



File Class:	Honcell Li-ion Polymer Datasheet-HCP Series	Version:	HCV-24-01
File Name:	Li-ion Polymer Rechargeable Battery Specification Sheet	Manufacturer:	Honcell Energy
Standards:	Compliant with IEC62133-2017 (TUV/UL), UN38.3, CE/FCC, UL1642, KC, PSE, BIS, GB31241, BSMI, Weracs, RoHS, Reach	Date of Issue:	2024-10-31

## Li-ion Polymer Rechargeable Battery Specification Sheet

Customer's P/N	HCP421428W
Honcell's P/N	HCP421428W
Voltage/Capacity/Wh	3.7V / 120mAh / 0.44Wh

Prepared By  Date: 2024-10-31	Checked By  Date: 2024-10-31	Approved By  Date: 2024-10-31
--	---	--

Customer Approval:

Comment (please comment and sign here with your approvals)

Signature:

Stamp:

Date:

Shenzhen Honcell Energy Company Limited

612, Bldg. A, Weidonglong Industrial Zone,  
Meilong Ave. 194#, Longhua District,  
Shenzhen, Guangdong Province, 518109, China  
[t] +86-755-2100-5221 info@honcell.com  
[f] +86-755-2100-0249 www.honcell.com



CONTENT

1: Modification History ..... P.3

2: Scope ..... P.4

3: Electrical Parameters ..... P.4

4: BOM Of Battery Pack And Mechanical Drawing ..... P.5

5: Protection Circuit Module (PCM) ..... P.6-7

6: Curves ..... P.8

7: Model No. Nomenclature ..... P.8

8: Date Code Nomenclature ..... P.8

9: Mechanical Specifications Of Bare Cell ..... P.9

10: Safety Testing For Bare Cell ..... P.9

11: Battery Reliability ..... P.10

12: The Requirements Of Measurements And Instrumentations ..... P.10

13: Packing ..... P.11

14: Storage ..... P.11

15: Handling Precautions And Safety Instructions ..... P.12-15

16: Warning ..... P.16

17: Warranty ..... P.16

18: Others ..... P.16

19: Abbreviations ..... P.16

1: Modification History

Revision	Date	Modifications	Remarks	Approved
ED-RE-00	2019-11-01	Newly Released		√
ED-RE-01	2019-11-14	Update Protection Circuit Module		√
ED-RE-02	2024-10-31	Update Specification Version		√

HONCELL+

## 2. Scope

This Specification sheet describes the basic performance, technical parameters, testing methods, warnings and cautions of the Li-ion Polymer rechargeable battery. The specification sheet only applies to the products manufactured by Shenzhen Honcell Energy Company Limited. Technical information in this datasheet are for reference purpose only but NOT constitute any warranty or presentation and subject to change without prior notice.

## 3. Electrical Parameters

No.	Item	Spec.	Remark		
1	Base Cell Model	HCP421428	3.7V, 120mAh, 0.44Wh		
2	Capacity [mAh]	Typ.	130	@0.2C discharge, 23±2°C	
		Min.	120	@0.2C discharge, 23±2°C	
3	Rated Voltage [V]	3.7	Cell voltage at 3.7 to 4.10V before shipping		
4	Charge Cut-off Voltage [V]	4.2			
5	Discharge Cut-off Voltage [V]	3.0			
6	Impedance (mΩ)	Cell	180	Measure the internal resistance with AC=1kHz (Since Wave) after standard charge	
		Cell+PCM	320		
7	Charge Current [mA]	Std.	@0.2C (24)	0 to 45°C	Constant Current (CC) and then with Constant Voltage (CV), Till Charge Current declines to 0.02C.
		Max.	@1.0C (120)	15 to 45°C	
8	Discharge Current [mA]	Std.	@0.2C (24)	-20 to 60°C	
		Max.	@1.0C (120)	10 to 60°C	Max. continuously discharge current
		Pulse	@2.0C (240)	10 to 60°C	Max. 2~3mS Burst
9	Operating Temp. [°C]	Charge	0 to 45		
		Discharge	-20 to 60		
10	Storage Temp. [°C]	12 Months	@ -10 to 25 ≥80%	@ SOC 50%, cell capacity recovery rate in time V.S %. Battery is always recommended to be stored at 23±2°C	
		3 Months	@ -20 to 35 ≥85%		
		1 Month	@ -20 to 45 ≥90%		
11	Cycle Life	≥500 times	CC@0.2C charges to 4.20V, and then with CV till the current declines to 0.02C. In 5 Mins., CC@0.2C, discharges to 3.0V. In 10Mins., repeat continuously till the capacity remained less than 80% of initial		
12	Self-discharge	Cell	95%	Store the batteries for 1 month at 23±2°C after std. charge and then discharged @0.2C to 3.0V cut off, or 0.08mV/h as a reference	
		Cell+PCM	90%		
13	Retention Capability	≥90%Cmin.	Store the batteries for 28 days at 23±2°C, then record the discharge time @0.2C to a cut off voltage at 3.0V		
14	Std. Condition	Temp.	15 to 35°C		
		Humidity	45-75%RH		
		Pressure	86-106KPa		
15	Approx. Weight [g]	5.0			

4. BOM of Battery Pack & Mechanical Drawing

4.1 Battery Pack Mechanical Drawing (Not In Scale)

\*\*\*All of the below materials are environmental friendly and RoHS compliant\*\*\*  
\*\*\*Unit : mm\*\*\*

No.	Item	Specification	Qty.
01	Base Cell Model	HCP421428	1
02	PCM(IC+MOSFET)	IC:S8261G3J MOS:DP8205	1
03	Lead Wires (P+)	UL3302-AWG#28	1
04	Lead Wires (P-)	UL3302-AWG#28	1
05	Top Insulation Tape	Orange Kapton	2
06	Printing Codes	As Shown	*
07	Crossed Wheel Bin	As Shown	1
08			
09			
10			

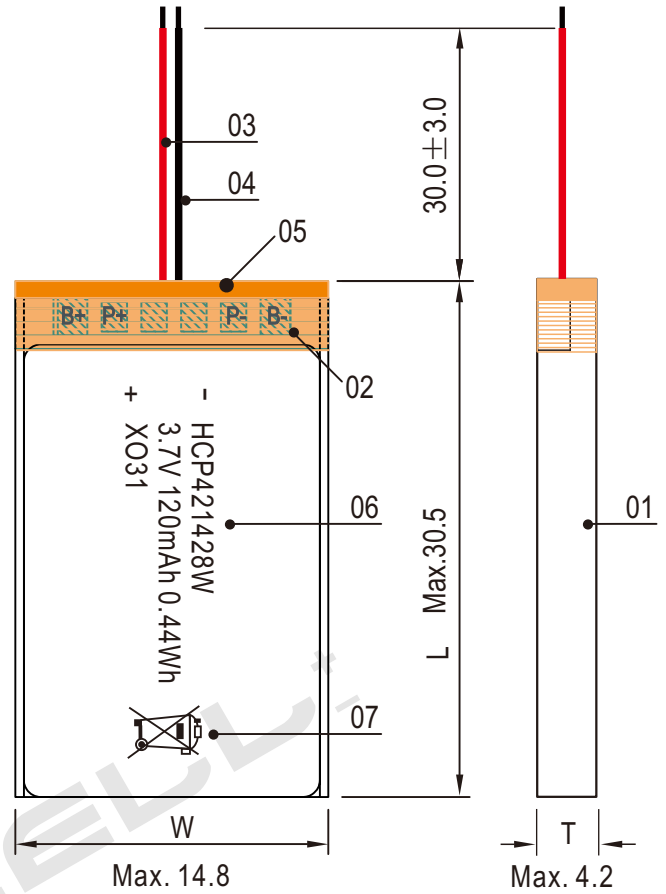

4.2 Bare Raw Cell Mechanical Drawing (Not In Scale)

▶ Thickness	T	Max. 4.2 (at delivery) Max. 4.54 (after cycles)
▶ Width	W	Max. 14.5
▶ Length	L	Max. 28.5 (exclude tabs)
▶ Tab Distance	B	6.0 ± 2.0
▶ Tab Length	A	6.0 ± 1.0
▶ Tab Width	C	2.0 ± 0.2
▶ Top Sealing Width	D	3.0 ± 0.5
▶ Top Sealant Height	E	1.5 for Ref.
▶ Weight Approx. [g]		2.6

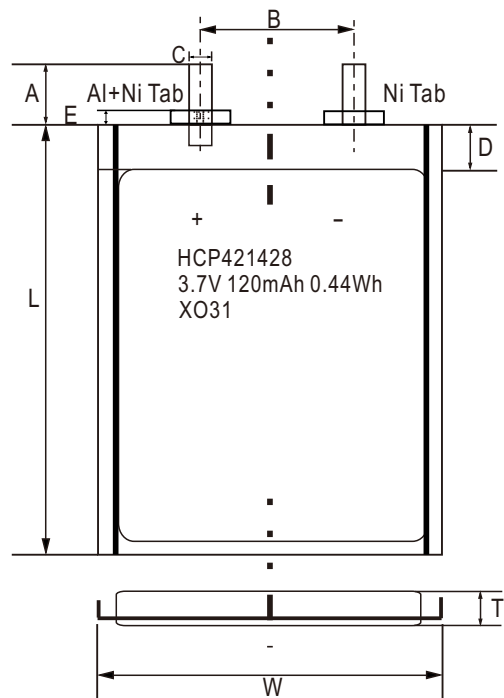

\*\*\*Measured with weighting 300fg @ 23±2°C\*\*\*  
\*\*\*Unit : mm\*\*\*

5. Protection Circuit Module (PCM)

5.1 Protection IC Connection Example

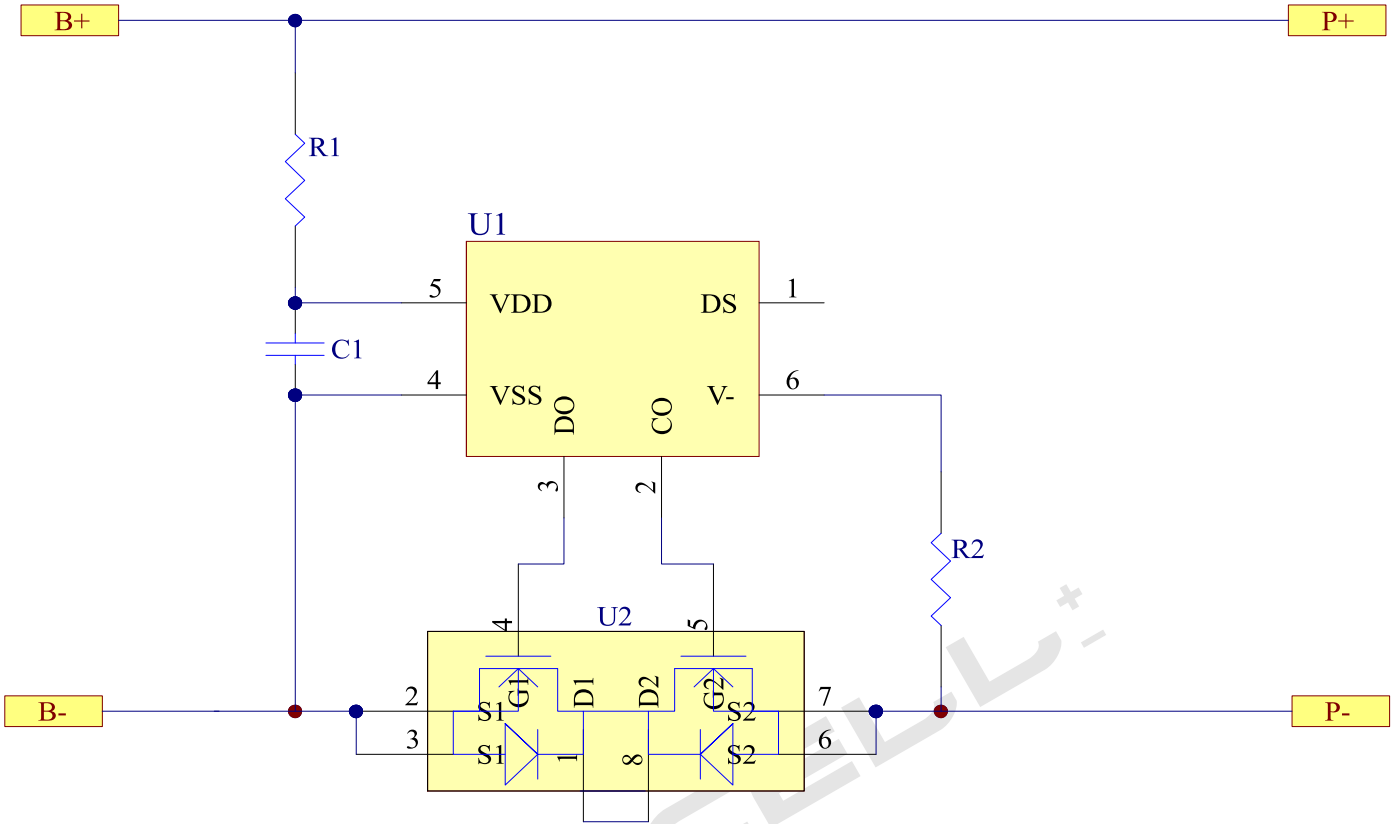

5.2 BOM of PCM

No.	Location	Item	Part Name	Package	Qty.	Supplier/ Remark
1	U1	Protection IC	S-8261G3J	SOT-23-6	1	SEIKO
2	U2	MOSFET	DP 8205	TSSOP-8	1	DP
3	R1	Resistor	SMD 330Ω±5%	0402/0603	1	YAGEO
4	R2	Resistor	SMD 470Ω±5%	0402/0603	1	YAGEO
5	C1	Capacitor	SMD 0.1μF±20%	0402/0603	1	YAGEO
6	PCB	PCB	(10.0*4.5*0.8)±0.15mm LxWxT		1	*****/FR-4 RoHS
7						
8						

5.3.1 PCM Top Layers (Not In Scale)

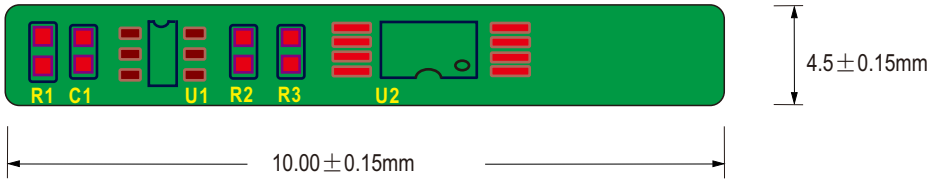

5.3.2 PCM Bottom Layers (Not In Scale)

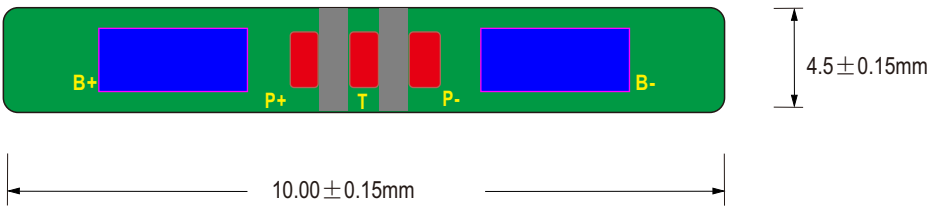

5.4 PCM Absolute Maximum Ratings (Ta=+25°C)

Item	Description	Symbol	Absolute Maximum Ratings
Overcharge Protection	Overcharge Detection Voltage	V <sub>CU</sub>	4.28±0.025V
	Overcharge Detection Delay Time	T <sub>CU</sub>	0.96s to 1.4s
	Overcharge Release Voltage	V <sub>CL</sub>	4.08±0.05V
Overdischarge Protection	Overdischarge Detection Voltage	V <sub>DL</sub>	3.0±0.05V
	Overdischarge Detection Delay Time	T <sub>DL</sub>	115.0ms to 173.0ms
	Overdischarge Release Voltage	V <sub>DU</sub>	3.0±0.05V
Overcurrent Protection	Overcurrent Detection Delay Time @ Charge	T <sub>CIOV</sub>	7.2mS to 11.0mS
	Overcurrent Detection Delay Time @ Discharge	T <sub>DIOV</sub>	7.2mS to 11.0mS
	Overcurrent Detection Current	I <sub>DP</sub>	1.0 to 4.0A
	Over Discharge Current Release Condition	/	Cut load
Short Circuit Protection	Load Short Circuit Detection Delay Time	T <sub>SHORT</sub>	220µs to 380µs Max.
	Release Condition	/	Cut short circuit
	Load Short Circuit Detection Voltage	V <sub>SHORT</sub>	1.2V±0.5V
Interior Resistance	Main Loop Electrify Resistance	R <sub>DS</sub>	VC=4.2V; R <sub>DS</sub> ≤60mΩ
Current Consumption	Normal Operation Mode	I <sub>OPE</sub>	1.0µA to 7.0µA Max.
	Power Down Mode	I <sub>PDN</sub>	0.1µA Max.
0V Battery Charge Function	Available / Unavailable	V <sub>OCHA</sub>	Available
Power Down Function	Yes / No	PDN	Yes





9. Mechanical Testing of Bare Raw Cell

No.	Item	Testing Condition and Method	Acceptance Criteria
1	Free Fall	At 23±2°C, after standard charge, drop the cell 3 times from a height of 1.0M onto a flat concrete floor or metal floor. The cells are dropped so as to obtain impacts in random orientations. Put the cells on rest for a Min. 1hr after drop, and then a visual inspection shall be performed.	No Fire, No Explosion
2	Vibration	Firmly fix the fully charged cell to the platform of vibration machine without distorting them in such a manner as to faithfully transmit the vibration. Test cells shall be subjected to sinusoidal vibration and the cycle shall be repeated 12 times for a total of approximately 3 hrs for each of 3 mutually perpendicular mounting positions. One of the directions shall be perpendicular to the terminal face. The frequency is to be varied at the rate of 1Hz per minute between 10 to 55Hz, the excursion of the vibration is 0.8mm.	No Fire, No Explosion No Leakage
3	Crush	After standard charge, immediately transfer and crush the cells between two flat surfaces in an ambient temperature. The force for the crushing is applied by a device exerting a force of 13kN±0.78kN. Once the maximum force has been applied, or an abrupt voltage drop of 1/3 of the original voltage has been obtained, the force is then released.	No Fire No Explosion No Rupture No Leakage or Venting
4	Mechanical Shock	After standard charge, secure the cells to the testing machine by means of a rigid mount which will support all mounting surfaces of each test cell. Each shall be subjected to 3 shocks in each direction of 3 mutually perpendicular mounting positions of the cell for a total of 18 shock. acceleration: 100m/s <sup>2</sup> ; frequency: 40 to 80 times / min; pulse duration: 6mS; impact times: 1000±10.	No Leakage No Venting No Rupture No Explosion No Fire
5	Needling	After standard charge at 1C, stab the cell with stainless steel needle with diameter 3-5mm on the biggest flat surface of the cell, the stab speed should be more than 40mm/s.	No Fire, No Explosion

10. Safety Testing for Bare Raw Cell

No.	Item	Testing Condition and Method	Acceptance Criteria
1	Over Charge	Discharged to the cut off voltage, and then charged at constant current of 3C and constant voltage of 4.6V while the voltage reaches its maximum and the current declines to zero, if the charge continues over 7 hours or the temperature is 20% less than the top, stop the test.	No Fire No Explosion
2	Over Discharge	At 23±2°C, discharged at 1C constant current, keep 6hrs.	No Fire No Explosion
3	External Short Circuit	At 23±2°C, short circuit the positive and negative terminals of the cells with a total external resistance of 80±20mΩ. The cells remain on test for 24 hrs or until the case temperature of the cell declines by 20% of the maximum temperature rise, whichever is the sooner. Typically refers to a condition where the per cell voltage below 0.8V.	No Fire No Explosion
4	Forced Discharge	Discharge a cell to the lower limit cut off voltage specified in this datasheet and then to be subjected to a forced discharge at 1C to the negative value of the upper limit charging voltage. The total duration for the forced discharge testing is 90 Mins.	No Fire No Explosion

## 11. Reliability Testing of Bare Raw Cells

No.	Item	Testing Condition and Method	Acceptance Criteria
1	Discharged at High Temperature	After standard charge, store the cells at $55\pm 2^{\circ}\text{C}$ for 2 hrs, and then discharged to the cut off voltage at a constant current of 0.2C, record the discharging time and capacity.	No distortion, no rupture, no fire, no smoke or no leakage. The discharge time $\geq 51$ Mins.
2	Discharged at Low Temperature	After standard charge, store the cells at $-20\pm 2^{\circ}\text{C}$ for 16hrs, and then discharged to the cut off voltage at a constant current of 0.2C, record the discharge time and capacity	No distortion, no rupture, no fire, no smoke or no leakage. Discharge time $\geq 180$ Mins.
3	Thermal Abuse	After standard charge, place the cells in a gravity or circulating air-convection oven, in an ambient temperature of $20\pm 3^{\circ}\text{C}$ for 1h. Then the oven temperature is raised at a rate of $5\pm 2^{\circ}\text{C}$ per minute to a temperature of $130\pm 2^{\circ}\text{C}$ . The cells remain at this temperature for 30 Mins. before the test is terminated.	No fire, no explosion.
4	Constant Temperature & Humidity	After standard charge, store the cells at ambient temperature of $40\pm 2^{\circ}\text{C}$ and the relative humidity between 90-95% for 48 hrs. After that, take out the cells and place it at ambient temperature of $23\pm 2^{\circ}\text{C}$ for 2hrs, and then discharged to the cut off voltage at a constant current of 0.2C.	No distortion, no rupture, no fire, no smoke or no leakage. Discharge time $\geq 180$ Mins.

\*\*\*Above tests of safety characteristics must be performed with protective devices\*\*\*

\*\*\*Above tests of the section #9, #10 and #11 are all tested according to UL1642 and or IEC62133-2017 for cells, and UL2054 or IEC62133-2017 for battery packs, and UN38.3 for shipping and packing instructions.\*\*\*

## 12. The Requirements of Measurements and Instrumentations

### 1: voltage instrumentation requirements

the voltage measuring meter accuracy no less than 0.5 magnitude

### 2: current instrumentation requirements

the current measuring meter accuracy no less than 0.5 magnitude

### 3: time instrumentation requirements

the time measuring meter accuracy no less than 0.1%

### 4: temperature instrumentation requirements

the temperature measuring meter accuracy no less than 0.5

### 5: impedance instrumentation requirements

the impedance measuring should by sinusoidal alternating (1 kHz) test

### 6: instrument for measuring dimension

accuracy must be more than 0.02mm, measuring rang is 150-200mm

### 7: instrument for measuring weight

accuracy must be more than 0.1g, measuring rang is 1.5kg

### 8: CC

the current of the constant flow source must be constant and adjusted, and the variation of the current must be within  $\pm 1\%$  when charging or discharging

### 9: CV

the voltage of the constant voltage source must be adjusted, and the variation of the voltage must be within  $\pm 0.5\%$

### 13. Packing

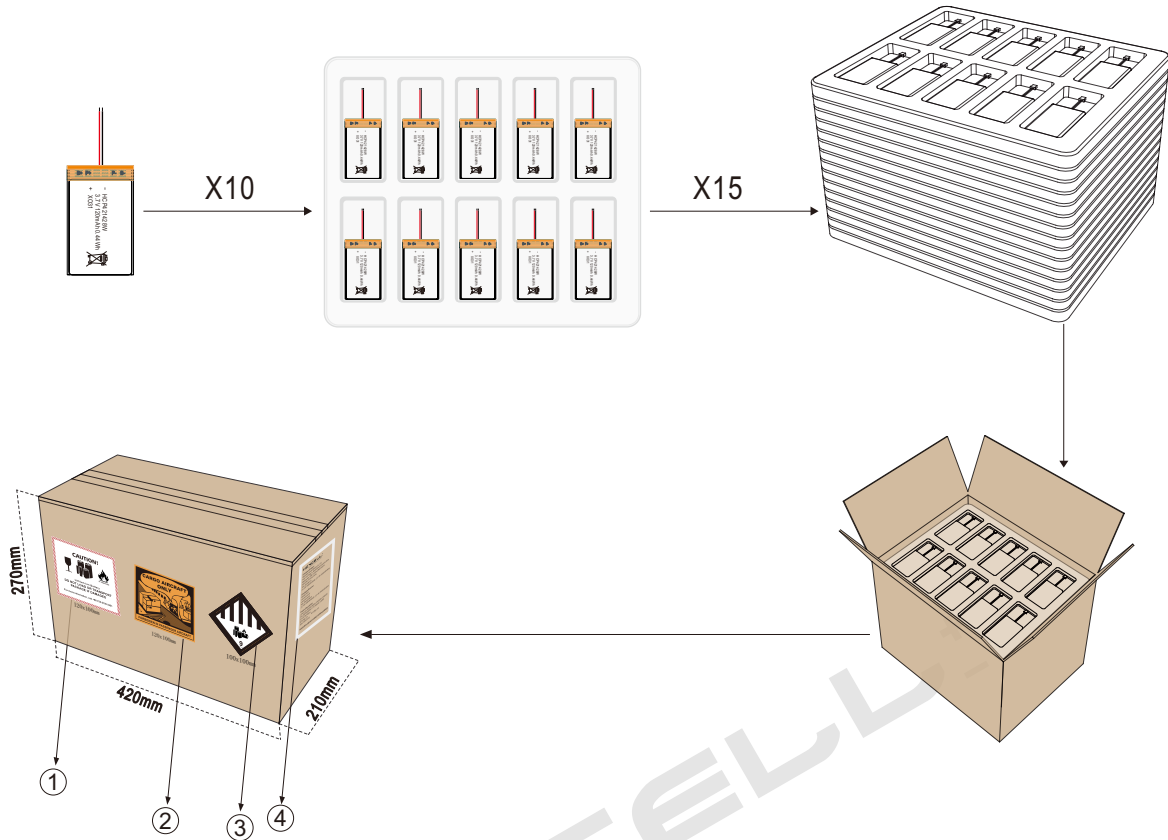

#### Remarks:

\*\*\*The packing details above is only for reference prior to datasheet was drawn and released, Honcell reserves the right to correct and modify the details upon shipping exactly according to the packing as it is.\*\*\*

- ① 120x100mm Fire Label Requested by UN38.3
- ② 120x100mm Cargo Aircraft Only Requested by UN38.3
- ③ 100x100mm #9 Classical Substances Vertical Bar Requested by UN38.3
- ④ 120x100mm Shipping Mark

### 14. Storage

Store the batteries in a cool and well-ventilated area away from heat source, open flames, corrosive chemicals, food and drink. Since short circuit can cause fire and generate heat, burn, leakage and rupture. Keep batteries in original packing until use and do NOT jumble them.

Keep the cells in half-charged state, SOC 50%. The cells/battery pack shall be stored at -20 to 50°C. Should the cells/ battery packs will be stored for 3 months or even longer time unused, transfer them to a dry and cool place. It is highly recommended to activate the battery at least 1 time every 3 months according to the following steps:

- 1) CC/CV charge @ 0.2C to 4.2V, till charge current declines to 0.02C.
- 2) then rest 5~10 min.
- 3) CC discharge @ 0.2C to 3.0V .
- 4) then rest 5~10 min.
- 5) CC charge again @ 0.2C to 3.9V

The voltage for a long time storage shall be 3.7V to 3.9V range. The environmental condition is preferred at ambient temperature 23±2°C and relative humidity 45-75%RH and 86-106KPa pressure

## 15. Handling Precautions and Guidelines for Lithium-ion Polymer Rechargeable Batteries

This document of "Handling Precautions and Guidelines for Li-ion Polymer Rechargeable Batteries" shall be applied to the battery cells manufactured by Honcell Energy. The customer is requested to contact Honcell in advance if and when the customer needs other applications or operating conditions than those described in this document. Additional experimentation may be required to verify performance and safety under such conditions. Honcell will take no responsibilities for any accidents when the cell is used under other conditions than those described in this document. Honcell will inform, in a written form, the customer of any improvements regarding proper use and handling of the cell, if it is deemed necessary.

### 15.1. Charge

Always use a charger specifically designed for Li-ion polymer batteries, but never use other types of chargers to charge the Lipo batteries. Failure to do so will damage the batteries and may cause fire and personal injury.

#### 15.1.1 Charge Current

Charging current should be less than maximum charge current specified in this datasheet. To charge with higher current than recommended value may cause damages to the cell electrical, mechanical and safety performances and could lead to heat generation or leakage.

#### 15.1.2 Charge Voltage

Charging shall be done by voltage less than that specified in this specification sheet (4.2V/cell). Charging beyond 4.25V, which is the absolute maximum voltage, must be strictly prohibited. The charger shall be designed to comply with this condition. It is very dangerous that charging with higher voltage than maximum voltage since it causes damage to the cell electrical, mechanical safety performances and could lead to heat generation or leakage.

#### 15.1.3 Charge Temperature:

The cell shall be charged at between 0 to 45°C.

#### 15.1.4 Prohibition of Reverse Charge:

Reverse charging is prohibited. The cell must be connected correctly. The polarity has to be confirmed before wiring, in case of the cell is connected improperly, the cell cannot be charged. Simultaneously, the reverse charging may cause damages to the cell which may lead to degradation of cell performances and damage the cell safety, and could cause heat generation or leakage.

### 15.2. Discharge

#### 15.2.1 Discharge current

The cell shall be discharged at less than the maximum discharge current specified in this data sheet. High discharge current may reduce the discharge capacity significantly or cause over-heat. If you plan to discharge battery at a higher current than the Max. current specified, please consult us for the HCG series.

#### 15.2.2 Discharge Temperature

The cell shall be discharged within -20 to +60°C range specified in this data sheet.

#### 15.2.3 Over-discharge

It should be noted that the cell would be at over-discharged state by its self-discharge characteristics in case the cell is not used for long time. Over-discharge may cause loss of cell performances, characteristics or battery functions. In order to prevent the cell over-discharging, the cell shall be charged periodically to maintain between 3.7V to 3.9V. The charger shall be equipped with a device to prevent further discharging exceeding a cut-off voltage specified in this data sheet. Also the charger shall be equipped with a device to control the recharging procedures as follows:

- a:** The cell or battery pack shall start with a low current (0.01C) for 15-30 minutes, i.e. pre-charge before rapid charge starts
- b:** The rapid charge shall be started after the (individual) cell voltage has been reached above 3.0V within 15-30 minutes. Can be determined with the use of an appropriate timer for pre-charge. In case the (individual) cell voltage does not rise to 3.0V within the pre-charge time, then the charger shall have functions to stop further charge and display the cell/pack is at abnormal state.

### 15.3. Protection Circuit Module (PCM)

The cell or battery pack shall be protected by PCM and has the functions of over charge, over discharge, over current and short circuit protection to maintain safety and prevent significant deterioration of cell performances

#### 15.3.1 Overcharge Prohibition

Overcharge prohibition function shall stop charging if any one of the cells of the battery pack reaches 4.25V.

### 15.3.2 Over-discharge Prohibition

Over-discharge prohibition function shall work to avoid further drop in cell voltage of 2.5V or less per cell in any cell of the battery pack. It is recommended that the dissipation current of PCM shall be minimized to 0.5uA or less with the over-discharge prevention. The protection function shall monitor each cell of the battery pack and control the current all the time.

### 15.4. Storage

Store the batteries in a cool and well-ventilated area away from heat source, open flames, corrosive chemicals, food and drink. Since short circuit can cause fire and generate heat, burn, leakage and rupture. Keep batteries in original packing until use and do NOT jumble them. Keep the cells in half-charged state, SOC 50%. The cells/battery pack shall be stored at -20 to 50°C. Should the cells/ battery packs will be stored for 3 months or even longer time unused, transfer them to a dry and cool place. It is highly recommended to activate the battery at least 1 time every 3 months according to the following steps:

- 1) CC/CV charge @ 0.2C to 4.2V then rest 5 min.
- 2) CC discharge @ 0.2C to 3.0V then rest 5 min.
- 3) CC charge again @ 0.2C to 3.9V

The voltage for a long time storage shall be 3.7V to 3.9V range. The environmental condition is preferred at ambient temperature 23±2°C and relative humidity 45-75%RH and 86-106KPa pressure

### 15.5. Handling of Cells

- 1) avoid any short-circuit. It will cause the leads to get hot and lose electrical functions
- 2) avoid touching the cells with sharp objects when handling and storing
- 3) avoid errors during assembly by contacting the positive lead with the negative lead
- 4) avoid mechanical shock to the cells
- 5) avoid electro-static discharge when using, charging, and storing cells
- 6) avoid putting the battery in contact with metal conductors such as neck chains, barrettes, or bolts, etc.
- 7) don't bend or fold the sealing edge
- 8) don't open the folded edge on the sides of the cell
- 9) don't bend the tabs
- 10) don't put the cells into an oven, washing machine or any high-voltage container.
- 11) don't use a charger without a safety certification
- 12) don't use metal conductors to connect the positive and negative leads together
- 13) do not store batteries in a manner that allow terminals to short circuit
- 14) do not place batteries near heating sources, nor exposed to direct sunlight for long periods
- 15) immediately stop charging if the cell overheats, emits an odor, changes color, shape, etc.
- 16) the children should be supervised by adults when using the batteries
- 17) before using batteries, please carefully read and understand the Handling Precautions and Safety Guidelines
- 18) keep away batteries from children.
- 19) store the batteries at a proper condition range specified in this specification sheet

#### 15.5.1 Soft Aluminum Foil

- 1) don't strike battery with any sharp edge parts
- 2) trim your nail or wear glove before taking battery
- 3) clean worktable to make sure no any sharp particle

#### 15.5.2 Sealed Edge

- 1) sealing edge is very flimsy
- 2) don't bend or fold the sealing edge

#### 15.5.3 Folding Edge

- 1) the folding edge is formed in battery process and passed all hermetic test.
- 2) don't open or deform folding edge.

#### 15.5.4 Tabs

- 1) the battery tabs are not so stubborn especially for aluminum tab
- 2) don't bend the tabs

#### 15.5.5 Mechanical Shock

Don't fall, hit and/or bend the battery body

## 15.6. Designing Battery Pack

### 15.6.1 Pack Designs

- 1) battery pack should have sufficient strength and the cell should be protected from mechanical shock
- 2) no Sharp edge components should be inside the pack containing the battery

### 15.6.2 PCM Designs

- 1) the over-charge threshold voltage should not be exceed 4.25V
- 2) the over-discharge threshold voltage should not be lower than 2.5V
- 3) the PCM must have over-charge, over-discharge, over current and short circuit protection function built-in designed

## 15.7. Battery Pack Assembling

### 15.7.1 Tab Connection

- 1) spot welding or hand soldering is recommended to connect battery tabs with PCM or other parts
- 2) if apply hand soldering to connect tabs with PCM, to ensure:
  - a. the soldering iron should be temperature controlled and ESD safe.
  - b. soldering temperature should not exceed 320°C
  - c. soldering time should not be longer than 3 seconds at a time
  - d. soldering time should not exceed 5
  - e. keep battery tab cold down before next time soldering.

### 15.7.2 Cell Fixing

- 1) the cell should be fixed to the battery pack by its largest surface area
- 2) there should be no sharp edges at the assembly contact area.
- 3) cells must be held firmly in the battery pack, and movement is not allowed

## 15.8. Prohibitions

### 15.8.1 Prevention of Short Circuit

Enough insulation layers between wiring and the cells shall be used to maintain extra safety protection

### 15.8.2 Prohibition of Disassembly

Never disassemble the cells, should a battery unintentionally be crushed, thus releasing its contents, rubber gloves must be used to handle all battery components. Avoid inhalation of any vapors that may be emitted

- 1) the disassembling may generate internal short circuit in the cell, which may cause gassing, firing, or other problems
- 2) electrolyte is harmful. Li-po battery should NOT have liquid from electrolyte flowing. In case of contacting the materials from a damaged or ruptured cell or battery, please follow the emergent instructions as below:
  - a. eye contact, wash immediately with plenty of water and soap or for at least 15 minutes
  - b. skin contact, wash immediately with water and soap
  - c. inhalation of vented gas, remove to fresh air
  - d. ingestion, seek medical attention immediately

### 15.8.3 Prohibition of Dumping of Cells into Fire

Never incinerate nor dispose the cells in fire or it causes firing.

### 15.8.4 Prohibition of Cells Immersion into Liquid

The cells shall never be soaked with liquids such as water, seawater, drinks such as soft drinks, juices, coffee or others.

### 15.8.5 Battery cells Replacement

The battery replacement shall be done only by authorized parties but never by users.

### 15.8.6 Prohibition of Use of Damaged Cells

The cells might be damaged during shipping. If any unusual features of the cells are found such as deformation, smelling of electrolyte, electrolyte leakage and or others, the cells shall never be used any more. The cells with a smell of the electrolyte or a leakage shall be placed away from fire to avoid firing.



### 15.9. Recommendations

- 1) to use the cells for specified equipments only
- 2) to use the cells in standard conditions specified in this datasheet
- 3) to avoid short the cells always
- 4) must NOT drop the cells into the water or fire
- 5) for long time unused, please keep them in a half-charged state, SOC 50%, neither fully charged nor fully discharged
- 6) store the cells in a cool and dry place at specified temperature and humidity condition
- 7) any matters with this specification arises, it shall be revised by mutual agreements
- 8) the children should be supervised by adults when using the batteries
- 9) before using batteries, please carefully read and understand the Handling Precautions and Safety Guidelines
- 10) avoid electro-static discharge when using, charging, and store the cells
- 11) avoid putting the battery in contact with metal conductors
- 12) avoid errors during assembly by contacting the positive with the negative
- 13) keep away batteries from children
- 14) do not store batteries in a manner that allows terminals to short circuit
- 15) do not place batteries near heating sources, nor exposed to direct sunlight for long periods

### 15.10. Precautions

- 1) do not strike battery with any sharp edge parts
- 2) do not immerse the battery in water or any other liquids
- 3) do not use and leave the battery near a heat source as fire or heater
- 4) do not reverse the positive and negative terminals
- 5) do not expose the lead wires
- 6) do not connect the battery to an electrical outlet
- 7) do not discard the battery in fire or heat it
- 8) do not assemble unmatched cells
- 9) do not charge a battery if deformed, swelled or appears damaged
- 10) do not bend the tabs since they are easily to be broken, especially the aluminum tab.
- 11) do not short-circuit the battery
- 12) do not transport and store the battery together with metal objects
- 13) do not pierce the battery with nails or other sharp objects
- 14) do not use or leave the battery at very high temperature
- 15) do not use it in a location where static electricity is obvious
- 16) do not use the batteries if odor, over heat, deformation observed
- 17) do not mix use the new and old cells or different brands
- 18) be aware of the over-discharged battery may cause fire or smoke
- 19) any time you have an accident with battery or if it balloons or exceeds temperature guidelines, follow these safety steps:
  - a. immediately remove the battery pack from your model or charger
  - b. place the battery in a non-flammable and well ventilated area
  - c. observe the battery for 30 minutes from a safe distance
  - d. after 30 minutes, if the pack appears stable not swelled and shows no signs of damage, return the battery

### 15.11. Battery Disposal Instructions

1. discharge battery pack to 2.5V per cell or less
2. fill a bucket with enough water to submerge the battery pack completely
3. add salt to the water until no more salt will dissolve and the water is fully saturated with salt
4. place the battery pack in the bucket and keep submerged in the salt water solution for 24 hours
5. remove the battery pack from the salt water and test the voltage
6. given the voltage does not read 0.0V, submerge again and re-test until the voltage reads 0.0V
7. once the battery pack has been discharged to 0.0 Volts, it is safe to dispose.

**16. Warning**

To charge and discharge the batteries may potentially cause fire or serious injury to persons and damages to property. The user of the battery agrees to accept responsibility for all of such risks. Honcell can't control the use, application, charge or installation of the battery, and shall not be held responsible for any accidents, injuries to persons, or damages to properties resulting from the misuse and or abuse of our products. Read all safety guidelines, charging instructions, and disposal instructions in this datasheet before using batteries. Keep batteries out of reach of children and pets. Children under the age of 18 must be supervised by an adult. By purchasing Honcell's batteries, buyers shall assume all risks associated with the batteries.

**17. Warranty**

Honcell Energy guarantees only to the original users that all batteries will be free of defects in material and workmanship for a period of 12 months. The applicable warranty period begins from the date of shipping, or if no obvious evidence is available to state the shipping date, refer to the date code on the product. In no case shall Honcell's liability with defects proven due to the manufacturing process instead of the customers abuse and or misuse, Honcell will at our options make any necessary repairs and or replacement free of charge only be allowed or accepted for return unless an official authorization. The warranty does not cover a battery reaching its normal end of life which may occur prior to the warranty periods stated above. A battery can deliver only a fixed number of usable amp-hours over its lifetime and is considered to have reached its normal end of life if the application uses up all of these amp-hours, regardless of the time the battery has been in service. Therefore Honcell reserves the right to deny a warranty claim if it determines the battery to be at its normal end of life, even if the claim is lodged within the applicable period.

**18. Others**

Any matters that not covered within this specification sheet should be conferred between the buyers and Honcell. This document may contain technical inaccuracies or typographical errors, and you should confirm the accuracy and completeness of all information before making any decisions related to the products you are to test, buy or use.

**19. Abbreviations for Batteries**

A	Ampere
AC	Alternating Current
Ah	Ampere-hour
BMS	Battery Management System
°C	Celsius Centigrade (temperature)
CC/CV	Constant Current Constant Voltage (charge method)
C-rate	Discharge Rate of a Battery
DC	Direct Current
DoD	Depth of Discharge
DOT	Department of Transportation (US)
kPa	Kilo-Pascal (pressure); 1kPa = 0.01 bar; 1kPa = 0.145psi
kWh	Kilowatt-hour (electrical power)
LCO	Lithium Cobalt Oxide
LFP	Lithium-iron Phosphate
LiCoO <sub>2</sub>	Lithium-ion Cobalt Oxide
LiFePO <sub>4</sub>	Lithium-iron Phosphate Oxide
Li-ion	Lithium-ion Battery (short form)
mAh	Milliampere-hours
NCA	Lithium-ion Battery with Nickel, Cobalt, Aluminum
NiCd	Nickel Cadmium (battery)
NiMH	Nickel Metal Hydride (battery)
NMC	Lithium-ion with Nickel, Manganese, Cobalt
NTC	Negative Temperature Coefficient
OCV	Open Circuit Voltage
PTC	Positive Temperature Coefficient
RC	Remote Control
SBS	Smart Battery System
SLA	Sealed Lead Acid (battery)
SoC	State-of-Charge
Wh	Watt-hour
Wh/Kg	Watt-hour per kilogram (measurement of specific energy)
Wh/L	Watt-hour per liter (measured in energy density)