

1. Data Sheet¹

Model Number: HCG-721437

2. Dimensions [mm]

Thickness	T	Max. 6.8 (at delivery) Max. 7.34 (after cycling)
Width	W	Max. 14.8
Length	L	Max. 37.0 (exclude tabs)
Tab Distance	B	7.5±2.0
Tab Length	A	9.0±1.0
Tab Width	C	2.0±0.2
Top Sealing Width	D	3.0±0.5
Top Sealant Height	E	1.5 for Ref.
Weight Approx. [g]		6.5

3. Electrical Parameter²

Nominal Voltage [V]		3.7 (rated)
Capacity [mAh]	Typ.	310 (0.2C @ 23±2°C)
	Min.	300 (0.2C @ 23±2°C)
Impedance Initial [mΩ]		≤65 @ AC1kHz, 4.2V
Charge Current ³	Std.	@ 1.0C (300mA) @10~45°C
	Max.	@ 2.0C (600mA) @15~45°C
Discharge Current	Std.	@ 1.0C (30mA) @-20~60°C
	Max.	@ 15.0C (4500mA) @10~60°C
	Pulse	@ 25.0C (7500mA) <3S @10~60°C
Discharge Cut-off Voltage [V]		3.0
Charge Cut-off Voltage [V]		4.2
Life Expectancy 23±2°C Charge@1.0C/Discharge@1.0C		≥80% after 300 cycles
Operating Temperature	Charge	10 to +45°C
	Discharge	-20 to +60°C
Storage Temperature ⁴	12 Months ≥80%	-10 to +25°C
	3 Months ≥85%	-20 to +30°C
	1 Month ≥90%	-20 to +45°C

4. Date Code Nomenclature

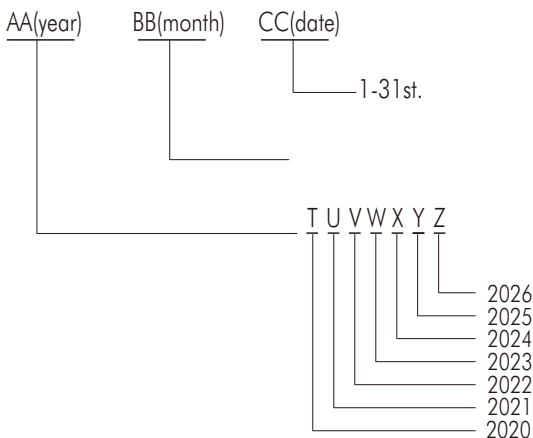

5. Mechanical Drawing (Not in Scale)

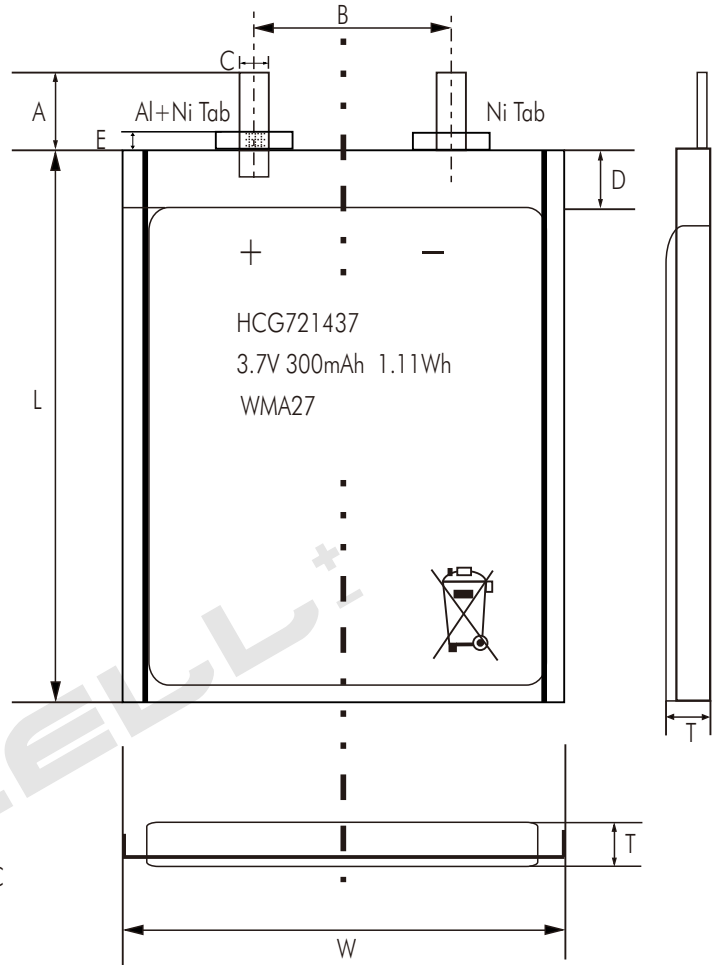

6. Safety Standards

- IEC62133-2017(TUV-CB), UN38.3, UL1642, KC, PSE, BIS, BSMI,
- MSDS, GB31241, REACH, RoHS, WERCS, CE, FCC

7. Delivery Status

Cell Voltage [V]	3.7-3.95
Cell Capacity [%]	30-70

8. Model No. Nomenclature

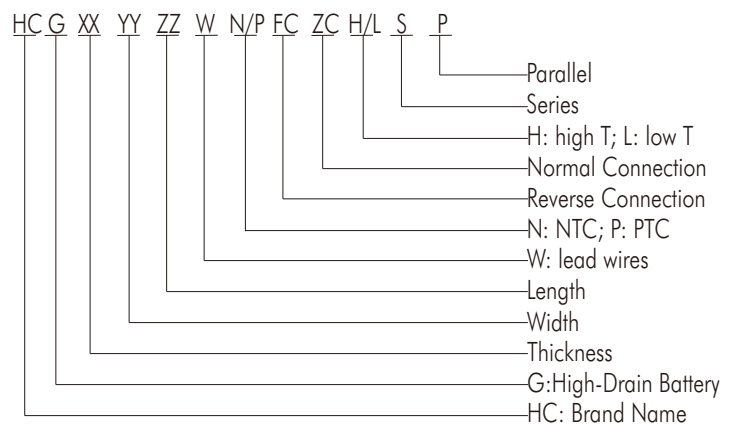

9. Curves (Reference)

Charge & Discharge (23±2°C)

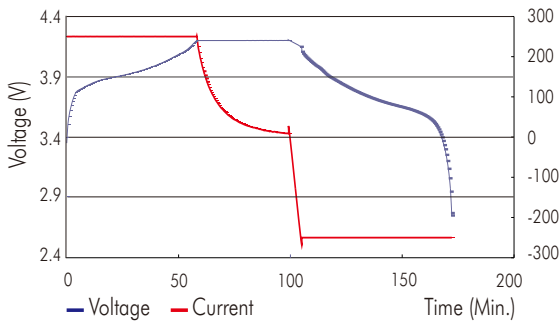

Cycle Life (23±2°C)

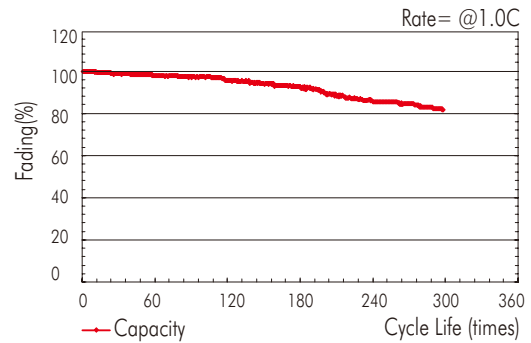

Discharge Characteristics (by Temp.)

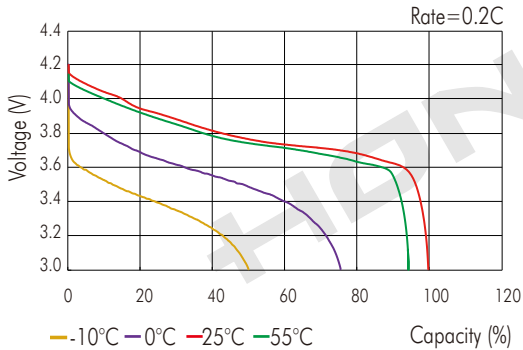

Discharge Characteristics (by rate)

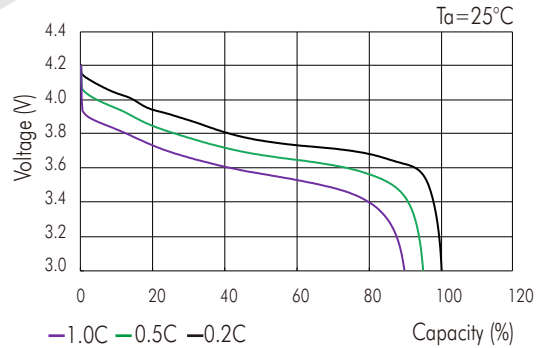

***¹: Prior to read Honcell "Handling Precautions and Guidelines For Lithium-ion Polymer Rechargeable Batteries" subject to change without prior notice

²: Technical information and contents in this datasheet are for reference purpose only but do NOT constitute any warranty or presentation and subject to change without prior notice. For most current information and further details, please contact us

***³: Charging the cell initially with Constant Current (CC) at 0.2C and then with Constant Voltage (CV) at 4.2V till charge current declines to 0.02C.

***⁴: At SOC 50%, cell capacity recovery rate in time VS %, battery is always recommended to be stored at 23±2°C

Shenzhen Honcell Energy Co., Ltd.

612, Bldg. A, Weidonglong Industrial Zone,
Meilong Ave. 194#, Longhua District,
Shenzhen, Guangdong Province, 518109, China
[+] +86-755-2100-5221 info@honcell.com
[f] +86-755-2100-0249 www.honcell.com