



Test Report issued under the responsibility of:



**TEST REPORT
IEC 62133-2**

Secondary cells and batteries containing alkaline or other non-acid electrolytes – Safety requirements for portable sealed secondary cells, and for batteries made from them, for use in portable applications – Part 2: Lithium systems

Report Number..... : **CN2237F9 001**
Date of issue..... : 2022-05-18
Total number of pages : 25 pages

Name of Testing Laboratory preparing the Report : Dongguan ZRLK Testing Technology Co., Ltd.

Applicant's name : Shenzhen Honcell Energy Co., Ltd.
Address..... : 612, Bldg. A, Weidonglong Industrial Zone, Meilong Ave. 194 #, Longhua New District, Shenzhen, 518109 Guangdong, P.R. China

Test specification:

Standard : IEC 62133-2:2017, IEC 62133-2:2017/AMD1:2021
Test procedure : CB Scheme
Non-standard test method : N/A

TRF template used..... : IECEE OD-2020-F1:2021, Ed.1.4
Test Report Form No. : IEC62133_2B
Test Report Form(s) Originator : DEKRA Certification B.V.
Master TRF : Dated 2021-08-31

Copyright © 2021 IEC System of Conformity Assessment Schemes for Electrotechnical Equipment and Components (IECEE System). All rights reserved.

This publication may be reproduced in whole or in part for non-commercial purposes as long as the IECEE is acknowledged as copyright owner and source of the material. IECEE takes no responsibility for and will not assume liability for damages resulting from the reader's interpretation of the reproduced material due to its placement and context.

If this Test Report Form is used by non-IECEE members, the IECEE/IEC logo and the reference to the CB Scheme procedure shall be removed.

This report is not valid as a CB Test Report unless signed by an approved IECEE Testing Laboratory and appended to a CB Test Certificate issued by an NCB in accordance with IECEE 02.

General disclaimer:

The test results presented in this report relate only to the object tested.
This report shall not be reproduced, except in full, without the written approval of the Issuing NCB. The authenticity of this Test Report and its contents can be verified by contacting the NCB, responsible for this Test Report.

Test item description	Lithium-ion polymer battery	
Trade Mark(s).....	N/A	
Manufacturer.....	Same as applicant	
Model/Type reference	HCP682235	
Ratings	3.8V, 550mAh, 2.09Wh	
Responsible Testing Laboratory (as applicable), testing procedure and testing location(s):		
<input checked="" type="checkbox"/>	CB Testing Laboratory:	Dongguan ZRLK Testing Technology Co., Ltd.
Testing location/ address	Building D, No.2, Jinyuyuan Industrial Park, No.18, West Industrial Road, Songshan Lake High-tech Industrial Development Zone, Dongguan City 523808, Guangdong, China	
Tested by (name, function, signature)	Ekko Wang (Engineer)	<i>Ekko Wang</i>
Approved by (name, function, signature).. :	Ailis Ma (Reviewer)	<i>Ailis Ma</i>
<input type="checkbox"/>	Testing procedure: CTF Stage 1:	
Testing location/ address		
Tested by (name, function, signature)		
Approved by (name, function, signature).. :		
<input type="checkbox"/>	Testing procedure: CTF Stage 2:	
Testing location/ address		
Tested by (name + signature)		
Witnessed by (name, function, signature). :		
Approved by (name, function, signature).. :		
<input type="checkbox"/>	Testing procedure: CTF Stage 3:	
<input type="checkbox"/>	Testing procedure: CTF Stage 4:	
Testing location/ address		
Tested by (name, function, signature)		
Witnessed by (name, function, signature). :		
Approved by (name, function, signature).. :		
Supervised by (name, function, signature) :		

<p>List of Attachments (including a total number of pages in each attachment): Attachment 1: (Republic of Korea) NATIONAL DIFFERENCES (3 pages); Attachment 2: Photo documentation (4 pages).</p>	
<p>Summary of testing:</p>	
<p>Tests performed (name of test and test clause): cl.5.6.2 Design recommendation; cl.7.1 Charging procedures for test purposes (for cells and batteries); cl.7.2.1 Continuous charging at constant voltage (cells); cl.7.2.2 Case stress at high ambient temperature (batteries); cl.7.3.1 External short-circuit (cells); cl.7.3.2 External short-circuit (batteries); cl.7.3.3 Free fall (cells and batteries); cl.7.3.4 Thermal abuse (cells); cl.7.3.5 Crush (cells); cl.7.3.6 Over-charging of battery; cl.7.3.7 Forced discharge (cells); cl.7.3.8 Mechanical tests (batteries); cl.7.3.9 Design evaluation – Forced internal short-circuit (cells). The electrolyte type of this cell doesn't belong to polymer, and the additional test cl.7.3.9 was carried out to evaluate the cell. Tests are made with the number of cells and batteries specified in IEC 62133-2:2017+A1 Table 1.</p>	<p>Testing location: Dongguan ZRLK Testing Technology Co., Ltd. Building D, No.2, Jinyuyuan Industrial Park, No.18, West Industrial Road, Songshan Lake High-tech Industrial Development Zone, Dongguan City 523808, Guangdong, China</p>
<p>Summary of compliance with National Differences (List of countries addressed): KR KR=Republic of Korea <input checked="" type="checkbox"/> The product fulfils the requirements of <u>EN 62133-2:2017+A1</u>.</p>	

Use of uncertainty of measurement for decisions on conformity (decision rule) :

No decision rule is specified by the IEC standard, when comparing the measurement result with the applicable limit according to the specification in that standard. The decisions on conformity are made without applying the measurement uncertainty ("simple acceptance" decision rule, previously known as "accuracy method").

Other:... (to be specified, for example when required by the standard or client, or if national accreditation requirements apply)

Information on uncertainty of measurement:

The uncertainties of measurement are calculated by the laboratory based on application of criteria given by OD-5014 for test equipment and application of test methods, decision sheets and operational procedures of IECEE.

IEC Guide 115 provides guidance on the application of measurement uncertainty principles and applying the decision rule when reporting test results within IECEE scheme, noting that the reporting of the measurement uncertainty for measurements is not necessary unless required by the test standard or customer.

Calculations leading to the reported values are on file with the NCB and testing laboratory that conducted the testing.

Copy of marking plate:

The artwork below may be only a draft. The use of certification marks on a product must be authorized by the respective NCBs that own these marks.

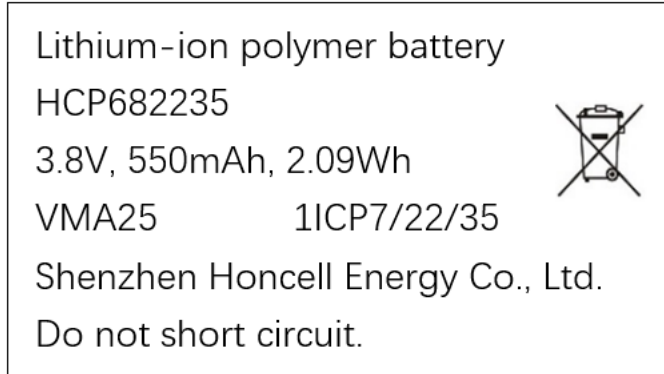

Battery Label

Caution:

1. Keep small cells and batteries which are considered swallowable out of the reach of children
2. Swallowing may lead to burns, perforation of soft tissue, and death. Severe burns can occur within 2 h of ingestion
3. In case of ingestion of a cell or battery, seek medical assistance promptly

Caution Label

Remark: 1). “VMA15” represents the date of manufacture, “V” represents the year of 2022, “MA” represents the month of March, “25” represents the day of 25th, detail see below:

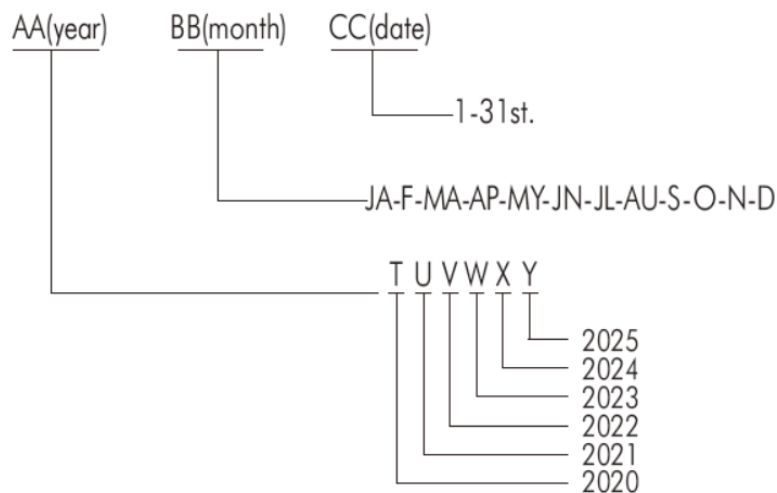

2). Caution label will be placed on the immediate package.

Test item particulars.....:	
Classification of installation and use.....:	N/A
Supply Connection	DC connector
Recommend charging method declared by the manufacturer	Charging the battery with 100mA constant current and 5.0V constant voltage until the current reduces to 11mA at ambient 20°C±5°C.
Discharge current (0,2 It A)	110mA
Specified final voltage.....:	3.0V
Upper limit charging voltage per cell.....:	4.35V
Maximum charging current	100mA
Charging temperature upper limit	45°C
Charging temperature lower limit.....:	0°C
Polymer cell electrolyte type.....:	<input type="checkbox"/> gel polymer <input type="checkbox"/> solid polymer <input checked="" type="checkbox"/> N/A
Possible test case verdicts:	
- test case does not apply to the test object.....:	N/A
- test object does meet the requirement.....:	P (Pass)
- test object does not meet the requirement.....:	F (Fail)
Testing.....:	
Date of receipt of test item	2022-03-23
Date (s) of performance of tests	2022-03-23 to 2022-04-29
General remarks:	
"(See Enclosure #)" refers to additional information appended to the report. "(See appended table)" refers to a table appended to the report.	
Throughout this report a <input type="checkbox"/> comma / <input checked="" type="checkbox"/> point is used as the decimal separator.	
Manufacturer's Declaration per sub-clause 4.2.5 of IEC62133 02:	
The application for obtaining a CB Test Certificate includes more than one factory location and a declaration from the Manufacturer stating that the sample(s) submitted for evaluation is (are) representative of the products from each factory has been provided	<input type="checkbox"/> Yes <input checked="" type="checkbox"/> Not applicable
When differences exist; they shall be identified in the General product information section.	
Name and address of factory (ies)	Same as applicant

General product information and other remarks:

This battery is constructed with single Li-ion cell, and has overcharge, over-discharge, over current and short-circuits proof circuit.

The main features of the battery are shown as below (clause 7.1.1):

Model	Rated capacity	Nominal voltage	Nominal Charge Current	Nominal Discharge Current	Maximum Charge Current	Maximum Discharge Current	Maximum Charge Voltage	Final Voltage
HCP682235	550mAh	3.8V	100mA	275mA for VSYS Output; 200mA for 1.8V Output	100mA	275mA for VSYS Output; 200mA for 1.8V Output	5.25V	3.0V

The main features of the cell in the battery are shown as below (clause 7.1.1):

Model	Rated capacity	Nominal voltage	Nominal Charge Current	Nominal Discharge Current	Maximum Charge Current	Maximum Discharge Current	Maximum Charge Voltage	Final Voltage
HCP682235 (Cell)	550mAh	3.8V	110mA	110mA	300mA	550mA	4.35V	3.0V

The main features of the cell in the battery are shown as below (clause 7.1.2):

Model	Upper limit charge voltage	Taper-off current	Lower charge temperature	Upper charge temperature
HCP682235 (Cell)	4.35V	27.5mA	0°C	45°C

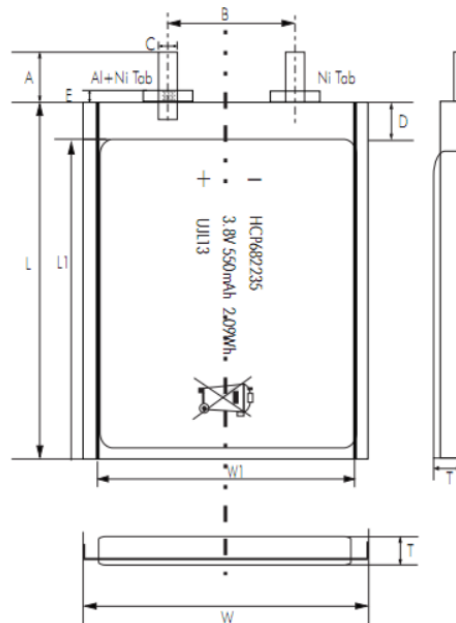
Construction:

$L*W*T=35.0 \text{ (max)}*22.0 \text{ (max)}*6.8 \text{ (max)}$
Cell (Unit: mm)

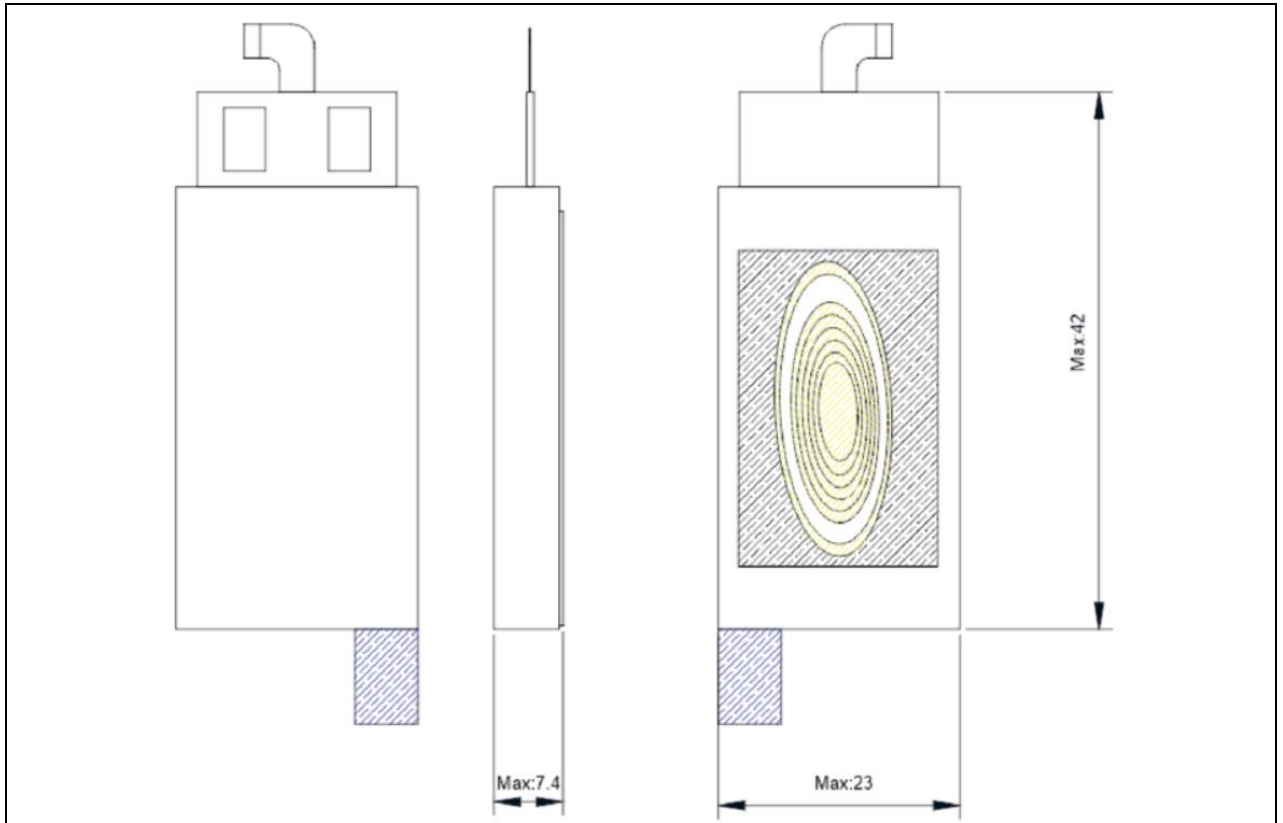

Battery (Unit: mm)

Circuit diagram:

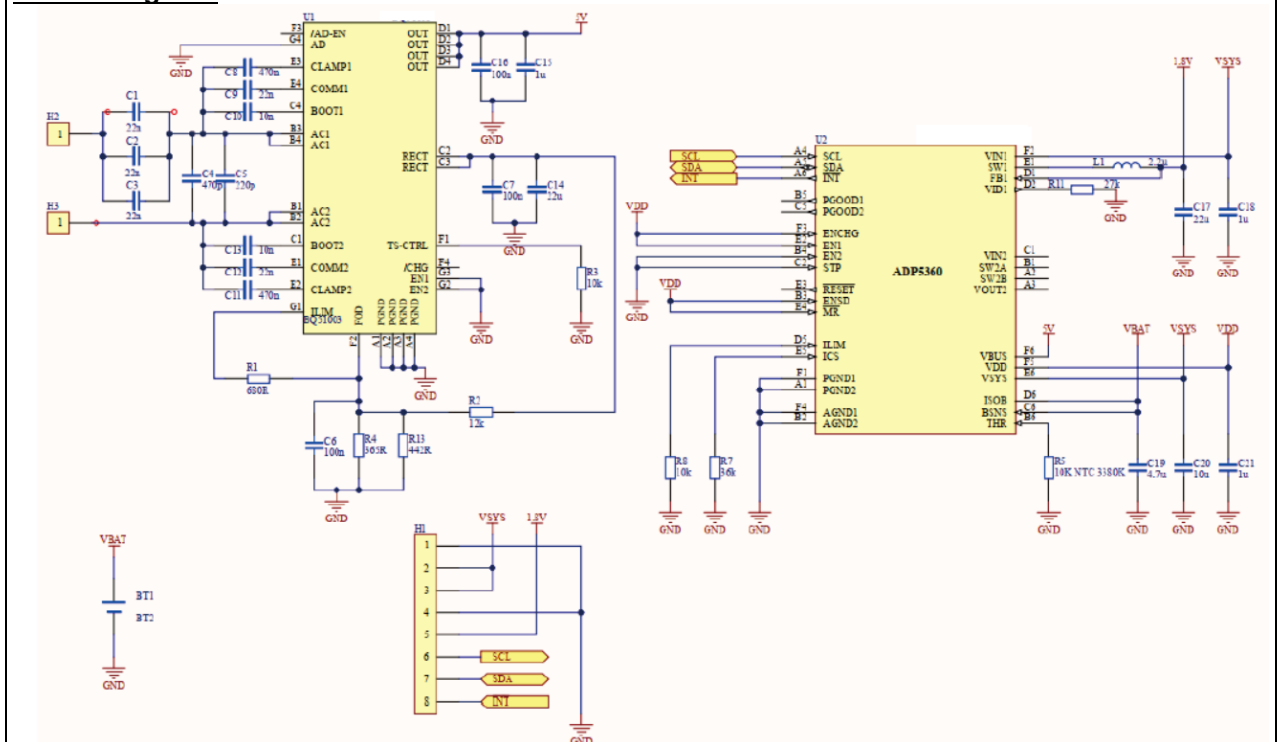

IEC 62133-2			
Clause	Requirement + Test	Result - Remark	Verdict
4	PARAMETER MEASUREMENT TOLERANCES		P
	Parameter measurement tolerances		P
5	GENERAL SAFETY CONSIDERATIONS		P
5.1	General		P
	Cells and batteries so designed and constructed that they are safe under conditions of both intended use and reasonably foreseeable misuse		P
5.2	Insulation and wiring		P
	The insulation resistance between the positive terminal and externally exposed metal surfaces of the battery (excluding electrical contact surfaces) is not less than 5 MΩ	No metal surface exists.	N/A
	Insulation resistance (MΩ) :	N/A	—
	Internal wiring and insulation are sufficient to withstand maximum anticipated current, voltage and temperature requirements		P
	Orientation of wiring maintains adequate clearances and creepage distances between conductors		P
	Mechanical integrity of internal connections accommodates reasonably foreseeable misuse		P
5.3	Venting		P
	Battery cases and cells incorporate a pressure relief mechanism or are constructed so that they relieve excessive internal pressure at a value and rate that will preclude rupture, explosion and self-ignition	Venting mechanism exists on the narrow side of pouch cell.	P
	Encapsulation used to support cells within an outer casing does not cause the battery to overheat during normal operation nor inhibit pressure relief		N/A
5.4	Temperature, voltage and current management		P
	Batteries are designed such that abnormal temperature rise conditions are prevented	Overcharge, over discharge, over current and short-circuit proof circuit used in this battery, see tests of clause 7.	P
	Batteries are designed to be within temperature, voltage and current limits specified by the cell manufacturer	See above.	P
	Batteries are provided with specifications and charging instructions for equipment manufacturers so that specified chargers are designed to maintain charging within the temperature, voltage and current limits specified	The charging limits specified in the manufacturer's specification.	P

IEC 62133-2			
Clause	Requirement + Test	Result - Remark	Verdict
5.5	Terminal contacts		P
	The size and shape of the terminal contacts ensure that they can carry the maximum anticipated current	DC connector complied with the requirements.	P
	External terminal contact surfaces are formed from conductive materials with good mechanical strength and corrosion resistance	DC connector complied with the requirements.	P
	Terminal contacts are arranged to minimize the risk of short circuits		P
5.6	Assembly of cells into batteries		P
5.6.1	General		P
	Each battery has an independent control and protection for current, voltage, temperature and any other parameter required for safety and to maintain the cells within their operating region	Protective circuit equipped on battery.	P
	This protection may be provided external to the battery such as within the charger or the end devices		N/A
	If protection is external to the battery, the manufacturer of the battery provide this safety relevant information to the external device manufacturer for implementation		N/A
	If there is more than one battery housed in a single battery case, each battery has protective circuitry that can maintain the cells within their operating regions		N/A
	Manufacturers of cells specify current, voltage and temperature limits so that the battery manufacturer/designer may ensure proper design and assembly	Current, voltage and temperature limits specified by cell manufacturer.	P
	Batteries that are designed for the selective discharge of a portion of their series connected cells incorporate circuitry to prevent operation of cells outside the limits specified by the cell manufacturer		N/A
	Protective circuit components are added as appropriate and consideration given to the end-device application		P
	The manufacturer of the battery provide a safety analysis of the battery safety circuitry with a test report including a fault analysis of the protection circuit under both charging and discharging conditions confirming the compliance	Safety analysis report provided by manufacturer.	P
5.6.2	Design recommendation		P

IEC 62133-2			
Clause	Requirement + Test	Result - Remark	Verdict
	For the battery consisting of a single cell or a single cellblock, it is recommended that the charging voltage of the cell does not exceed the upper limit of the charging voltage specified in Table 2	When the battery pack is charged at 5.25V, the cell voltage will not exceed 4.35V.	P
	For the battery consisting of series-connected plural single cells or series-connected plural cellblocks, it is recommended that the voltages of any one of the single cells or single cellblocks does not exceed the upper limit of the charging voltage, specified in Table 2, by monitoring the voltage of every single cell or the single cellblocks		N/A
	For the battery consisting of series-connected plural single cells or series-connected plural cellblocks, it is recommended that charging is stopped when the upper limit of the charging voltage is exceeded for any one of the single cells or single cellblocks by measuring the voltage of every single cell or the single cellblocks		N/A
	For batteries consisting of series-connected cells or cell blocks, nominal charge voltage are not counted as an overcharge protection		N/A
	For batteries consisting of series-connected cells or cell blocks, cells have closely matched capacities, be of the same design, be of the same chemistry and be from the same manufacturer		N/A
	It is recommended that the cells and cell blocks are not discharged beyond the cell manufacturer's specified final voltage	Final voltage of battery: 3.0V, not exceed the final voltage specified by cell manufacturer.	P
	For batteries consisting of series-connected cells or cell blocks, cell balancing circuitry are incorporated into the battery management system		N/A
5.6.3	Mechanical protection for cells and components of batteries		P
	Mechanical protection for cells, cell connections and control circuits within the battery are provided to prevent damage as a result of intended use and reasonably foreseeable misuse	Mechanical protection for cell connections and control circuits provided.	P
	The mechanical protection can be provided by the battery case or it can be provided by the end product enclosure for those batteries intended for building into an end product	Build-in batteries, mechanical protection for cells should be provided by end product.	N/A
	The battery case and compartments housing cells are designed to accommodate cell dimensional tolerances during charging and discharging as recommended by the cell manufacturer	To be evaluated in final system.	N/A

IEC 62133-2			
Clause	Requirement + Test	Result - Remark	Verdict
	For batteries intended for building into a portable end product, testing with the battery installed within the end product is considered when conducting mechanical tests		N/A
5.7	Quality plan	Complied.	P
	The manufacturer prepares and implements a quality plan that defines procedures for the inspection of materials, components, cells and batteries and which covers the whole process of producing each type of cell or battery	Quality plan provided.	P
5.8	Battery safety components		N/A
6	TYPE TEST AND SAMPLE SIZE		P
	Tests are made with the number of cells or batteries specified in Table 1 using cells or batteries that are not more than six months old		P
	The internal resistance of coin cells are measured in accordance with Annex D. Coin cells with internal resistance less than or equal to 3 Ω are tested in accordance with Table 1	Not coin cells	N/A
	Unless otherwise specified, tests are carried out in an ambient temperature of 20 °C \pm 5 °C		P
	The safety analysis of 5.6.1 identify those components of the protection circuit that are critical for short-circuit, overcharge and over discharge protection		P
	When conducting the short-circuit test, consideration is given to the simulation of any single fault condition that is likely to occur in the protecting circuit that would affect the short-circuit test	See clause 7.3.2.	P
7	SPECIFIC REQUIREMENTS AND TESTS		P
7.1	Charging procedure for test purposes		P
7.1.1	First procedure		P
	This charging procedure applies to subclauses other than those specified in 7.1.2		P
	Unless otherwise stated in this document, the charging procedure for test purposes is carried out in an ambient temperature of 20 °C \pm 5 °C, using the method declared by the manufacturer	See page 6.	P
	Prior to charging, the battery has been discharged at 20 °C \pm 5 °C at a constant current of 0,2 It A down to a specified final voltage	See page 6.	P
7.1.2	Second procedure		P

IEC 62133-2			
Clause	Requirement + Test	Result - Remark	Verdict
	This charging procedure applies only to 7.3.1, 7.3.4, 7.3.5, and 7.3.9		P
	After stabilization for 1 h to 4 h, at an ambient temperature of the highest test temperature and the lowest test temperature, respectively, as specified in Table 2, cells are charged by using the upper limit charging voltage and maximum charging current, until the charging current is reduced to 0,05 It A, using a constant current to constant voltage charging method	Charge temperature 0-45°C declared; 45°C used for upper limit test temperature; -5°C used for lower limit test temperature.	P
7.2	Intended use		P
7.2.1	Continuous charging at constant voltage (cells)	Tested complied.	P
	Fully charged cells are subjected for 7 days to a charge using the charging method for current and standard voltage specified by the cell manufacturer	Charging for 7 days with 110mA and 4.2V.	P
	Results: no fire, no explosion, no leakage..... :	(See appended table 7.2.1)	P
7.2.2	Case stress at high ambient temperature (battery)	Tested as client requested.	P
	Oven temperature (°C)..... :	70	—
	Results: no physical distortion of the battery case resulting in exposure of internal protective components and cells	No physical distortion of the battery.	P
7.3	Reasonably foreseeable misuse		P
7.3.1	External short-circuit (cell)	Tested complied.	P
	The cells were tested until one of the following occurred:		P
	- 24 hours elapsed; or		N/A
	- The case temperature declined by 20 % of the maximum temperature rise		P
	Results: no fire, no explosion..... :	(See appended table 7.3.1)	P
7.3.2	External short-circuit (battery)	Tested complied.	P
	The batteries were tested until one of the following occurred:		P
	- 24 hours elapsed; or		N/A
	- The case temperature declined by 20 % of the maximum temperature rise		P
	In case of rapid decline in short circuit current, the battery pack remained on test for an additional one hour after the current reached a low end steady state condition		P

IEC 62133-2			
Clause	Requirement + Test	Result - Remark	Verdict
	A single fault in the discharge protection circuit is conducted on one to four (depending upon the protection circuit) of the five samples before conducting the short-circuit test	Shorting single fault conducted on two samples.	P
	A single fault applies to protective component parts such as MOSFET (metal oxide semiconductor field-effect transistor), fuse, thermostat or positive temperature coefficient (PTC) thermistor	Shorting single fault applies on IC U2 (Pin F2-Pin D6) for VSYS Output, IC U2 (Pin D1-Pin D6) for 1.8V Output.	P
	Results: no fire, no explosion..... :	(See appended table 7.3.2)	P
7.3.3	Free fall	Tested complied.	P
	Results: no fire, no explosion	No fire. No explosion	P
7.3.4	Thermal abuse (cells)	Tested complied.	P
	Oven temperature (°C)..... :	130	—
	Results: no fire, no explosion	No fire. No explosion	P
7.3.5	Crush (cells)	Tested complied.	P
	The crushing force was released upon:		P
	- The maximum force of 13 kN ± 0,78 kN has been applied; or		P
	- An abrupt voltage drop of one-third of the original voltage has been obtained		N/A
	Results: no fire, no explosion..... :	(See appended table 7.3.5)	P
7.3.6	Over-charging of battery		P
	The supply voltage which is:		P
	- 1,4 times the upper limit charging voltage presented in Table A.1 (but not to exceed 6,0 V) for single cell/cell block batteries or	6.0V applied.	P
	- 1,2 times the upper limit charging voltage resented in Table A.1 per cell for series connected multi-cell batteries, and		N/A
	- Sufficient to maintain a current of 2,0 It A throughout the duration of the test or until the supply voltage is reached	1.1A applied.	P
	Test was continued until the temperature of the outer casing:		P
	- Reached steady state conditions (less than 10 °C change in 30-minute period); or		P
	- Returned to ambient		N/A
	Results: no fire, no explosion..... :	(See appended table 7.3.6)	P
7.3.7	Forced discharge (cells)	Tested complied.	P

IEC 62133-2			
Clause	Requirement + Test	Result - Remark	Verdict
	Discharge a single cell to the lower limit discharge voltage specified by the cell manufacturer		P
	The discharged cell is then subjected to a forced discharge at 1 It A to the negative value of the upper limit charging voltage		P
	- The discharge voltage reaches the negative value of upper limit charging voltage within the testing duration. The voltage is maintained at the negative value of the upper limit charging voltage by reducing the current for the remainder of the testing duration		N/A
	- The discharge voltage does not reach the negative value of upper limit charging voltage within the testing duration. The test is terminated at the end of the testing duration		P
	Results: no fire, no explosion	(See appended table 7.3.7)	P
7.3.8	Mechanical tests (batteries)		P
7.3.8.1	Vibration	Tested complied.	P
	Results: no fire, no explosion, no rupture, no leakage or venting.	(See appended table 7.3.8.1)	P
7.3.8.2	Mechanical shock	Tested complied.	P
	Results: no leakage, no venting, no rupture, no explosion and no fire	(See appended table 7.3.8.2)	P
7.3.9	Design evaluation – Forced internal short-circuit (cells)	Tested complied.	P
	The cells complied with national requirement for	France, Japan, Republic of Korea and Switzerland	—
	The pressing was stopped upon:		P
	- A voltage drop of 50 mV has been detected; or		N/A
	- The pressing force of 800 N (cylindrical cells) or 400 N (prismatic cells) has been reached	400 N for prismatic cells	P
	Results: no fire	(See appended table 7.3.9)	P
8	INFORMATION FOR SAFETY		P
8.1	General		P
	Manufacturers of secondary cells provides information about current, voltage and temperature limits of their products	Information for safety mentioned in manufacturer's specifications.	P
	Manufacturers of batteries provides information regarding how to minimize and mitigate hazards to equipment manufacturers or end-users	Information for safety mentioned in manufacturer's specifications.	P

IEC 62133-2			
Clause	Requirement + Test	Result - Remark	Verdict
	Systems analyses are performed by device manufacturers to ensure that a particular battery design prevents hazards from occurring during use of a product		N/A
	As appropriate, any information relating to hazard avoidance resulting from a system analysis is provided to the end user		N/A
8.2	Small cell and battery safety information	Small cell and battery.	P
	The following warning language is to be provided with the information packaged with the small cells and batteries or equipment using them:	See marking plate on page 5.	P
	- Keep small cells and batteries which are considered swallowable out of the reach of children		P
	- Swallowing may lead to burns, perforation of soft tissue, and death. Severe burns can occur within 2 h of ingestion		P
	- In case of ingestion of a cell or battery, seek medical assistance promptly		P
9	MARKING		P
9.1	Cell marking	The final product is battery	N/A
	Cells are marked as specified in IEC 61960, except coin cells		N/A
	Coin cells whose external surface area is too small to accommodate the markings on the cells show the designation and polarity		N/A
	By agreement between the cell manufacturer and the battery and/or end product manufacturer, component cells used in the manufacture of a battery need not be marked		N/A
9.2	Battery marking		P
	Batteries are marked as specified in IEC 61960, except for coin batteries	See marking plate on page 5.	P
	Coin batteries whose external surface area is too small to accommodate the markings on the batteries show the designation and polarity	Not coin battery	N/A
	Batteries are marked with an appropriate caution statement	Batteries also marked with an appropriate caution statement	P
	- Terminals have clear polarity marking on the external surface of the battery, or	DC connector used.	N/A
	- Not be marked with polarity markings if the design of the external connector prevents reverse polarity connections	Keyed external connectors can prevent reverse polarity connections.	P

IEC 62133-2			
Clause	Requirement + Test	Result - Remark	Verdict
9.3	Caution for ingestion of small cells and batteries		N/A
	Coin cells and batteries identified as small batteries include a caution statement regarding the hazards of ingestion in accordance with 8.2	Not coin cells and batteries.	N/A
	Small cells and batteries are intended for direct sale in consumer-replaceable applications, caution for ingestion is given on the immediate package	Not direct sale battery.	N/A
9.4	Other information		P
	The following information are marked on or supplied with the battery:		P
	- Storage and disposal instructions	Information for storage and disposal instructions mentioned in manufacturer's specifications.	P
	- Recommended charging instructions	Information for recommended charging instructions mentioned in manufacturer's specifications.	P
10	PACKAGING AND TRANSPORT		N/A
	Packaging for coin cells are not be small enough to fit within the limits of the ingestion gauge of Figure 3	Not coin cells.	N/A
ANNEX A	CHARGING AND DISCHARGING RANGE OF SECONDARY LITHIUM ION CELLS FOR SAFE USE		P
A.1	General		P
A.2	Safety of lithium ion secondary battery	Complied	P
A.3	Consideration on charging voltage	Complied	P
A.3.1	General		P
A.3.2	Upper limit charging voltage	4.35V	P
A.3.2.1	General		P
A.3.2.2	Explanation of safety viewpoint		P
A.3.2.3	Safety requirements, when different upper limit charging voltage is applied	4.35V applied.	P
A.4	Consideration of temperature and charging current		P
A.4.1	General		P
A.4.2	Recommended temperature range	See A.4.2.2.	P
A.4.2.1	General		P

IEC 62133-2			
Clause	Requirement + Test	Result - Remark	Verdict
A.4.2.2	Safety consideration when a different recommended temperature range is applied	Charging temperature declared by client is: 0-45°C	P
A.4.3	High temperature range	Not higher than the temperature range specific in this standard.	N/A
A.4.3.1	General		N/A
A.4.3.2	Explanation of safety viewpoint		N/A
A.4.3.3	Safety considerations when specifying charging conditions in the high temperature range	45°C applied	N/A
A.4.3.4	Safety considerations when specifying a new upper limit in the high temperature range		N/A
A.4.4	Low temperature range	Charging low temperature declared by client is: 0°C.	P
A.4.4.1	General		P
A.4.4.2	Explanation of safety viewpoint		P
A.4.4.3	Safety considerations, when specifying charging conditions in the low temperature range	-5°C applied	P
A.4.4.4	Safety considerations when specifying a new lower limit in the low temperature range	No documents provided by manufacturer explaining the lower limit exceed 10°C, -5°C applied for testing in this report for safety considerations.	P
A.4.5	Scope of the application of charging current		P
A.4.6	Consideration of discharge		P
A.4.6.1	General		P
A.4.6.2	Final discharge voltage and explanation of safety viewpoint	Cell specified final voltage 3.0V.	P
A.4.6.3	Discharge current and temperature range		P
A.4.6.4	Scope of application of the discharging current		P
A.5	Sample preparation		P
A.5.1	General		P
A.5.2	Insertion procedure for nickel particle to generate internal short		P
A.5.3	Disassembly of charged cell		P
A.5.4	Shape of nickel particle		P
A.5.5	Insertion of nickel particle in cylindrical cell		N/A
A.5.5.1	Insertion of nickel particle in winding core		N/A
A.5.5.2	Marking the position of the nickel particle on both ends of the winding core of the separator		N/A

IEC 62133-2			
Clause	Requirement + Test	Result - Remark	Verdict
A.5.6	Insertion of nickel particle in prismatic cell		P
A.6	Experimental procedure of the forced internal short-circuit test		P
A.6.1	Material and tools for preparation of nickel particle		P
A.6.2	Example of a nickel particle preparation procedure		P
A.6.3	Positioning (or placement) of a nickel particle		P
A.6.4	Damaged separator precaution		P
A.6.5	Caution for rewinding separator and electrode		P
A.6.6	Insulation film for preventing short-circuit		P
A.6.7	Caution when disassembling a cell		P
A.6.8	Protective equipment for safety		P
A.6.9	Caution in the case of fire during disassembling		P
A.6.10	Caution for the disassembling process and pressing the electrode core		P
A.6.11	Recommended specifications for the pressing device		P
ANNEX B	RECOMMENDATIONS TO EQUIPMENT MANUFACTURERS AND BATTERY ASSEMBLERS		N/A
ANNEX C	RECOMMENDATIONS TO THE END-USERS		N/A
ANNEX D	MEASUREMENT OF THE INTERNAL AC RESISTANCE FOR COIN CELLS		N/A
D.1	General	Not coin cells.	N/A
D.2	Method		N/A
	A sample size of three coin cells is required for this measurement		N/A
	Coin cells with an internal resistance greater than 3 Ω require no further testing	(See appended table D.2)	N/A
	Coin cells with an internal resistance less than or equal to 3 Ω are subjected to the testing according to Clause 6 and Table 1		N/A
ANNEX E	PACKAGING AND TRANSPORT		N/A
ANNEX F	COMPONENT STANDARDS REFERENCES		N/A

IEC 62133-2			
Clause	Requirement + Test	Result - Remark	Verdict

7.2.1	TABLE: Continuous charging at constant voltage (cells)				P
Sample No.	Recommended charging voltage Vc (Vdc)	Recommended charging current I _{rec} (A)	OCV before test (Vdc)	Results	
Cell #1	4.35	0.11	4.34	P	
Cell #2	4.35	0.11	4.34	P	
Cell #3	4.35	0.11	4.34	P	
Cell #4	4.35	0.11	4.34	P	
Cell #5	4.35	0.11	4.34	P	
Supplementary information:					
- No fire or explosion					
- No leakage					

7.3.1	TABLE: External short circuit (cell)					P
Sample No.	Ambient (°C)	OCV at start of test (Vdc)	Resistance of circuit (mΩ)	Maximum case temperature rise ΔT (°C)	Results	
Samples charged at charging temperature upper limit (45°C)						
Cell 6#	54.7	4.33	85	124.8	P	
Cell 7#	54.7	4.32	77	123.9	P	
Cell 8#	54.7	4.32	79	122.6	P	
Cell 9#	54.7	4.32	84	123.9	P	
Cell 10#	54.7	4.33	83	123.6	P	
Samples charged at charging temperature lower limit (-5°C)						
Cell 11#	56.4	4.24	86	123.3	P	
Cell 12#	56.4	4.25	80	127.3	P	
Cell 13#	56.4	4.24	79	124.8	P	
Cell 14#	56.4	4.25	81	125.2	P	
Cell 15#	56.4	4.25	78	124.9	P	
Supplementary information:						
- No fire or explosion						

IEC 62133-2			
Clause	Requirement + Test	Result - Remark	Verdict

7.3.2	TABLE: External short circuit (battery)					P
Sample No.	Ambient T (°C)	OCV before test (Vdc)	Resistance of circuit (mΩ)	Maximum case temperature rise ΔT , °C	Component single fault condition	Results
VSYS Output						
Battery 4#	22.0	4.15	82	119.9	IC U2 (Pin F2-Pin D6) S-C	P
Battery 5#	22.0	4.16	84	108.6	IC U2 (Pin F2-Pin D6) S-C	P
Battery 6#	22.0	4.15	76	22.7	--	P
Battery 7#	22.0	4.16	79	22.7	--	P
Battery 8#	22.0	4.15	83	22.5	--	P
1.8V Output						
Battery 9#	22.5	4.15	85	110.9	IC U2 (Pin D1-Pin D6) S-C	P
Battery 10#	22.5	4.15	80	120.5	IC U2 (Pin D1-Pin D6) S-C	P
Battery 11#	22.5	1.81	79	22.9	--	P
Battery 12#	22.5	1.80	86	22.8	--	P
Battery 13#	22.5	1.81	84	22.7	--	P
Supplementary information:						
- No fire or explosion						
-S-C: short circuit						

7.3.5	TABLE: Crush (cells)				P
Sample No.	OCV before test (Vdc)	OCV at removal of crushing force (Vdc)	Maximum force applied to the cell during crush (kN)	Results	
Samples charged at charging temperature upper limit (45°C)					
Cell 29#	4.33	4.33	13	P	
Cell 30#	4.32	4.32	13	P	
Cell 31#	4.33	4.33	13	P	
Cell 32#	4.33	4.33	13	P	
Cell 33#	4.32	4.32	13	P	
Samples charged at charging temperature lower limit (-5°C)					
Cell 34#	4.24	4.24	13	P	

IEC 62133-2				
Clause	Requirement + Test		Result - Remark	Verdict
Cell 35#	4.25	4.25	13	P
Cell 36#	4.25	4.25	13	P
Cell 37#	4.25	4.25	13	P
Cell 38#	4.24	4.24	13	P
Supplementary information:				
- No fire or explosion				
Note: A 13kN force applied at the wide side of prismatic cells.				

7.3.6	TABLE: Over-charging of battery				P
Constant charging current (A)		1.1		—	
Supply voltage (Vdc)		6.0		—	
Sample No.	OCV before charging (Vdc)	Total charging time (minute)	Maximum outer case temperature (°C)	Results	
Battery 17#	3.35	500	26.0	P	
Battery 18#	3.39	500	25.3	P	
Battery 19#	3.37	500	26.0	P	
Battery 20#	3.35	500	25.7	P	
Battery 21#	3.40	500	25.5	P	
Supplementary information:					
- No fire or explosion					

7.3.7	TABLE: Forced discharge (cells)				P
Sample No.	OCV before application of reverse charge (Vdc)	Measured reverse charge I_t (A)	Lower limit discharge voltage (Vdc)	Results	
Cell 39#	3.09	0.55	3.0	P	
Cell 40#	3.05	0.55	3.0	P	
Cell 41#	3.15	0.55	3.0	P	
Cell 42#	3.16	0.55	3.0	P	
Cell 43#	3.20	0.55	3.0	P	
Supplementary information:					
- No fire or explosion					

IEC 62133-2			
Clause	Requirement + Test	Result - Remark	Verdict

7.3.8.1	TABLE: Vibration					P
Sample No.	OCV before test (Vdc)	OCV after test (Vdc)	Mass before test (g)	Mass after test (g)	Results	
Battery 22#	4.15	4.13	11.948	11.944	P	
Battery 23#	4.16	4.14	11.970	11.963	P	
Battery 24#	4.16	4.14	11.929	11.924	P	
Supplementary information:						
- No fire or explosion						
- No rupture						
- No leakage						
- No venting						

7.3.8.2	TABLE: Mechanical shock					P
Sample No.	OCV before test (Vdc)	OCV after test (Vdc)	Mass before test (g)	Mass after test (g)	Results	
Battery 25#	4.16	4.15	11.959	11.957	P	
Battery 26#	4.16	4.15	11.937	11.935	P	
Battery 27#	4.15	4.14	11.965	11.962	P	
Supplementary information:						
- No fire or explosion						
- No rupture						
- No leakage						
- No venting						

IEC 62133-2			
Clause	Requirement + Test	Result - Remark	Verdict

7.3.9	TABLE: Forced internal short circuit (cells)					P
Sample No.	Chamber ambient T (°C)	OCV before test (Vdc)	Particle location ¹⁾	Maximum applied pressure (N)	Results	
Samples charged at charging temperature upper limit (45°C)						
Cell 44#	45	4.31	1	400	P	
Cell 45#	45	4.30	1	400	P	
Cell 46#	45	4.30	1	400	P	
Cell 47#	45	4.31	1*	400	P	
Cell 48#	45	4.31	1*	400	P	
Samples charged at charging temperature lower limit (-5°C)						
Cell 49#	-5	4.22	1	400	P	
Cell 50#	-5	4.22	1	400	P	
Cell 51#	-5	4.23	1	400	P	
Cell 52#	-5	4.22	1*	400	P	
Cell 53#	-5	4.23	1*	400	P	
Supplementary information:						
¹⁾ Identify one of the following: 1: Nickel particle inserted between positive and negative (active material) coated area. 2: Nickel particle inserted between positive aluminium foil and negative active material coated area. *: No location 2 exist. - No fire						

D.2	TABLE: Internal AC resistance for coin cells				N/A
Sample no.	Ambient T (°C)	Store time (h)	Resistance Rac (Ω)	Results ¹⁾	
--	--	--	--	--	
--	--	--	--	--	
--	--	--	--	--	
Supplementary information:					

IEC 62133-2					
Clause	Requirement + Test		Result - Remark		Verdict
TABLE: Critical components information					P
Object / part No.	Manufacturer / trademark	Type / model	Technical data	Standard	Mark(s) of conformity ¹⁾
FPC	SHENZHEN THRETEK TECHNOLOGY CO LTD	THR002(Note 1)	120°C, V-0	UL 94 UL 796F	UL E360726
FPC (Alternative)	Interchangeable	Interchangeable	Min. 120°C, V-0	UL 94 UL 796F	UL approved
Qi Receiver IC (U1)	Texas Instruments	bq51003	V _{OUT} : 5V, T _J : -40 to 150°C	--	Tested with appliance
PMIC (U2)	ANALOG DEVICES	ADP5360	VBUS to PGND1: -0.5V to 20V, Operating Junction: -40 to 85°C	--	Tested with appliance
Cell	Shenzhen Honcell Energy Co., Ltd.	HCP682235 (Cell)	3.8V, 550mAh	IEC 62133-2:2017+A1	Tested with appliance
-Electrolyte	SHANTOU JINGUANG HIGH-TECH CO., LTD.	A1938	LiPF ₆ , EC, EMC, DMC	--	--
-Separator	Shanghai Energy New Materials Technology Co., Ltd	ND20	PE, 20µm (T), Shutdown temperature: 130°C	--	--
-Negative electrode	JIANGXI ZHENG TUO NEW ENERGY TECHNOLOGY CO.,LTD.	0.140mm(T)	Graphite, CMC, SBR, H ₂ O, Conductive Additive, Copper foil	--	--
-Positive electrode	Dongguan Kai Xiang Industrial Co., LTD	0.120mm(T)	LiCoO ₂	--	--
-Aluminum plastic film	DAI NIPPON PRINTING CO.,LTD	D-EL40H	113µm (T), Nylon, PP, Aluminum	--	--
Supplementary information:					
1) Provided evidence ensures the agreed level of compliance. See OD-CB2039.					

-- End of Report --

IEC62133_2A ATTACHMENT			
Clause	Requirement + Test	Result - Remark	Verdict
ATTACHMENT TO TEST REPORT IEC 62133-2 (Republic of Korea) NATIONAL DIFFERENCES (Secondary cells and batteries containing alkaline or other non-acid electrolytes - Safety requirements for portable sealed secondary lithium cells, and for batteries made from them, for use in portable applications - Part 2: Lithium systems)			
Differences according to : National standard KC62133-2(2020-07)			
TRF template used: : IECEE OD-2020-F3, Ed. 1.1			
Attachment Form No. : KR_ND_IEC62133_2A			
Attachment Originator : KTR			
Master Attachment : Dated 2020-09-25			
Copyright © 2020 IEC System for Conformity Testing and Certification of Electrical Equipment (IECEE), Geneva, Switzerland. All rights reserved.			
	National Differences		P
7.3.6	Over-charging of battery		P
(Revision)	[Add the bolded text] b) Test The test shall be carried out in an ambient temperature of 20 °C ± 5 °C. Each test battery shall be discharged at a constant current of 0,2 It A, to a final discharge voltage specified by the manufacturer. Sample batteries shall then be charged at a constant current of 2,0 It A, using a supply voltage which is: <ul style="list-style-type: none"> • 1,4 times the upper limit charging voltage presented in Table A.1 (but not to exceed 6,0 V) for single cell/cell block batteries or • 1,2 times the upper limit charging voltage presented in Table A.1 per cell for series connected multi-cell batteries, and • sufficient to maintain a current of 2,0 It A throughout the duration of the test or until the supply voltage is reached. <u>• In case the charging voltage specified by the manufacturer is higher than the overcharge test voltage, the maximum charging voltage specified by manufacturer should be applied with 2.0 ItA,</u> <u>(e.g., quick charging power bank, etc.)</u>	See page 14 and table 7.3.6 of main report.	P

IEC62133_2A ATTACHMENT			
Clause	Requirement + Test	Result - Remark	Verdict
	<p>[Replace to the following statement]</p> <p>c) Acceptance criteria</p> <p>Overcharging exceeding to the limits specified by the manufacturer should not result in fire or explosion.</p>	See table 7.3.6 of main report.	P
Annex G	Definition for shape and materials of outer case for cell		—
<i>(Addition)</i>	<p>G.1 General</p> <p>Annex G provides definitions for shape and materials of outer case for cell</p> <p>G.2 Shape of outer case for cell</p> <p>G 2.1 Cylindrical cell</p> <p>Cell with a cylindrical shape in which the overall height is equal to or greater than diameter.</p> <p>G 2.2 Prismatic cell</p> <p>Cell having the shape of a parallelepiped whose faces are rectangular</p> <p>G.3 Materials of outer case for cell</p> <p>G.3.1 Soft case</p> <p>Non-metallic outer case or container for cell</p> <p>G.3.2 Hard case</p> <p>Metallic outer case or container for cell.</p>	<p>(Shape of outer cases)</p> <p><input type="checkbox"/> Cylindrical</p> <p><input checked="" type="checkbox"/> Prismatic</p> <p>(Materials of outer cases)</p> <p><input type="checkbox"/> Hard</p> <p><input checked="" type="checkbox"/> Soft</p>	—
Annex H	Calculation method of the volumetric energy density for cell		—
<i>(Addition)</i>	<p>Annex H provide a calculation method of the volumetric energy density for cell in use of smart phone, tablet, notebook.</p> <p>H.1 General</p> <p>Unless otherwise stated in the Annex E, the dimensions for calculation are based on these for cell before shipment and the volumetric energy density shall be calculated with a maximum values specified by manufacturer. If the specification for cell can't be provided a dimension for calculation, the manufacturer's other documentation shall be provided to demonstrate compliance for its calculation.</p>	399.2Wh/L	—

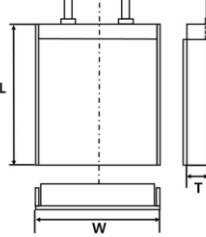
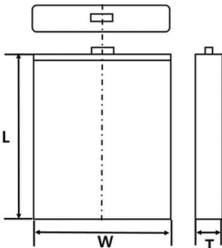
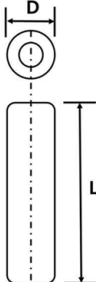
IEC62133_2A ATTACHMENT			
Clause	Requirement + Test	Result - Remark	Verdict
	<p>H.2 Calculation Method</p>  <p>L : Length (max.) of cell (including terrace) W : Width (max.) of cell T : Thickness (max.) when shipping charge (For reference, Please Exclude the dimension of any tape that is attached to cell)</p> $\text{Volumetric energy density (Wh/L)} = \frac{\text{Nominal voltage (V)} \times \text{Rated capacity (Ah)}}{\text{Length (L)} \times \text{Width (W)} \times \text{Thickness (T)}}$ <p>[H.1 – Prismatic cell using soft case]</p>  <p>L : Length (max.) of cell W : Width (max.) of cell T : Thickness when shipping charge (For reference, Please Exclude the dimension of any tape that is attached to cell)</p> $\text{Volumetric energy density (Wh/L)} = \frac{\text{Nominal voltage (V)} \times \text{Rated capacity (Ah)}}{\text{Length (L)} \times \text{Width (W)} \times \text{Thickness (T)}}$ <p>[H.2 – Prismatic cell using hard case]</p>  <p>D : Diameter (max.) of cell L : Length (max.) of cell (According to shape of cell at shipping, The dimension of tube for cell may be included In overall dimension of cell)</p> $\text{Volumetric energy density (Wh/L)} = \frac{\text{Nominal voltage (V)} \times \text{Rated capacity (Ah)}}{3.14159 \times \frac{\text{Diameter (D)}^2}{4} \times \text{Length(L)}}$ <p>[H.3 – Cylindrical cell using hard case]</p>		—

Product: Lithium-ion polymer battery

Type Designation: HCP682235

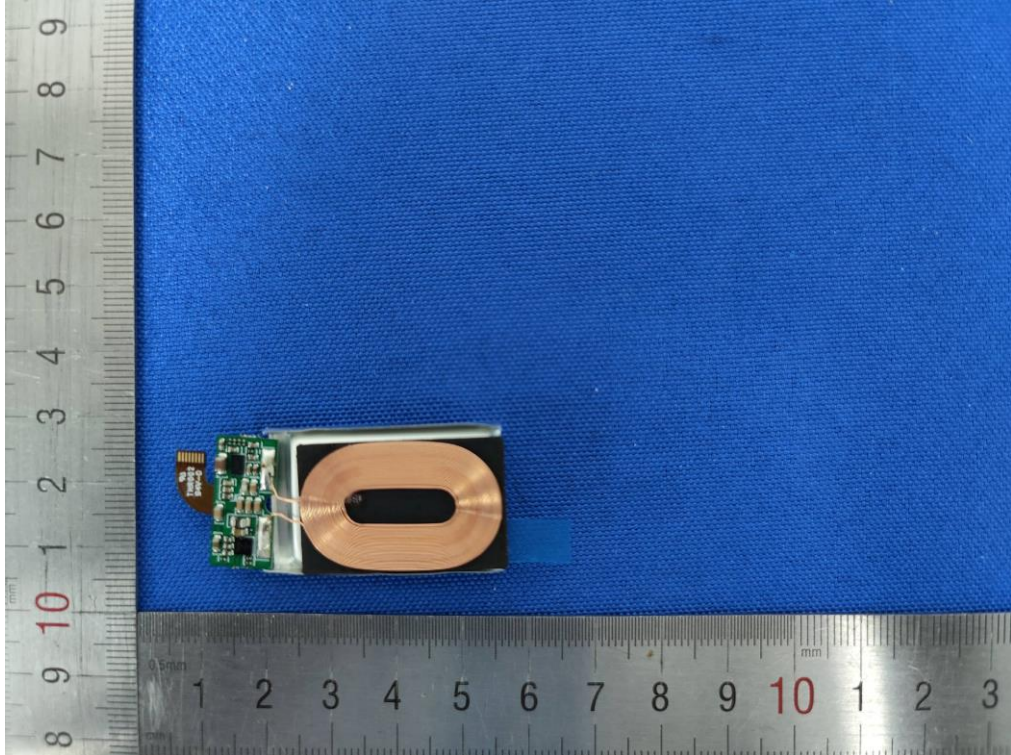

Figure 1 Front view of battery

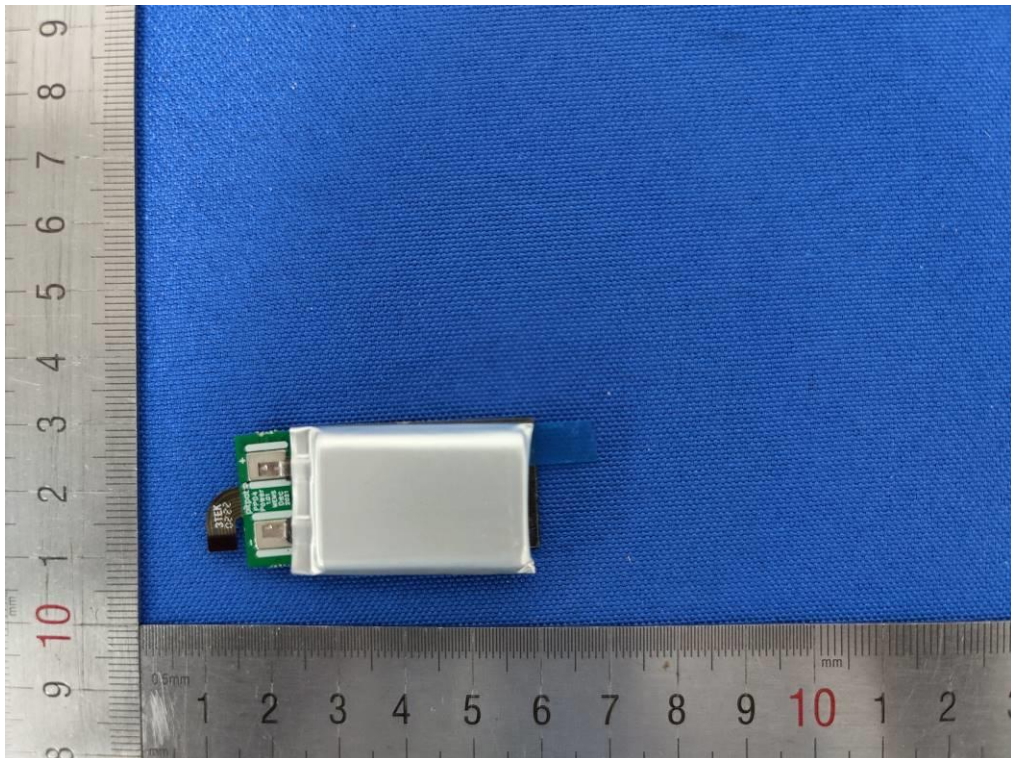

Figure 2 Back view of battery

Product: Lithium-ion polymer battery

Type Designation: HCP682235

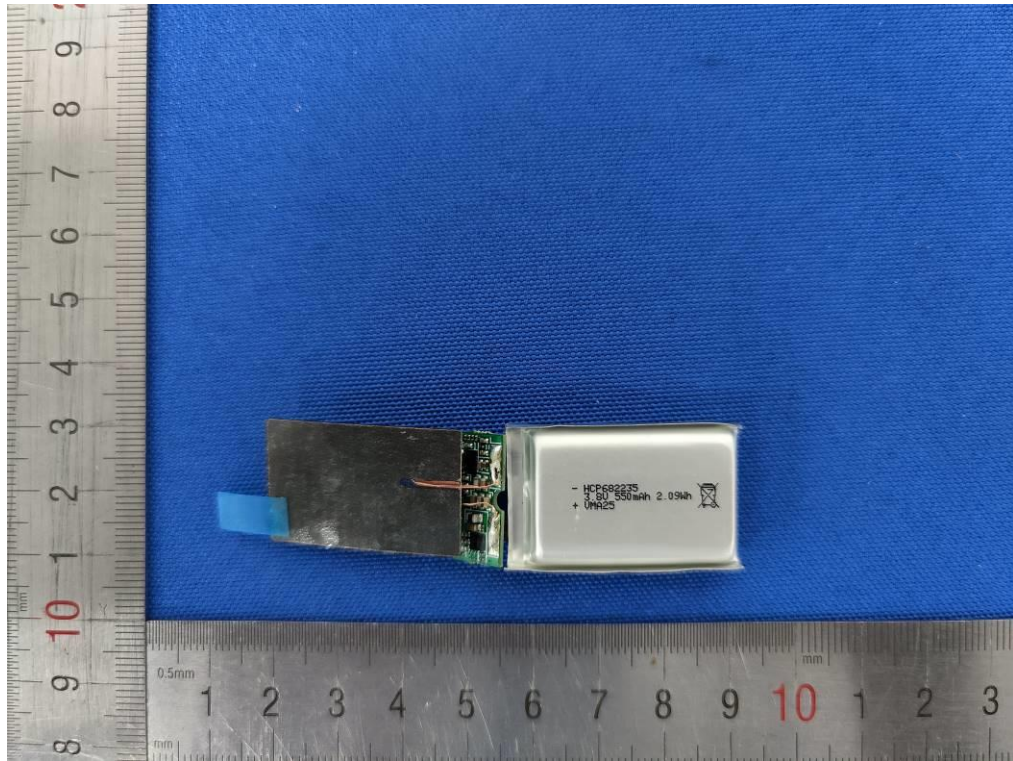

Figure 3 Marking view of battery

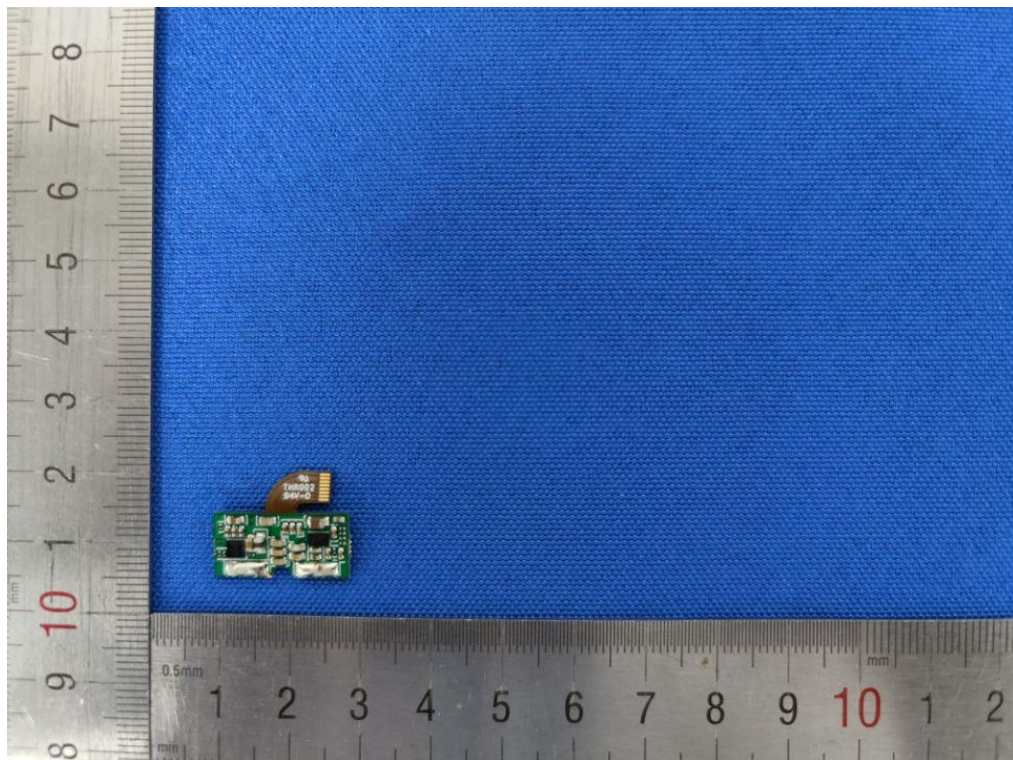

Figure 4 Front view of PCB

Product: Lithium-ion polymer battery

Type Designation: HCP682235

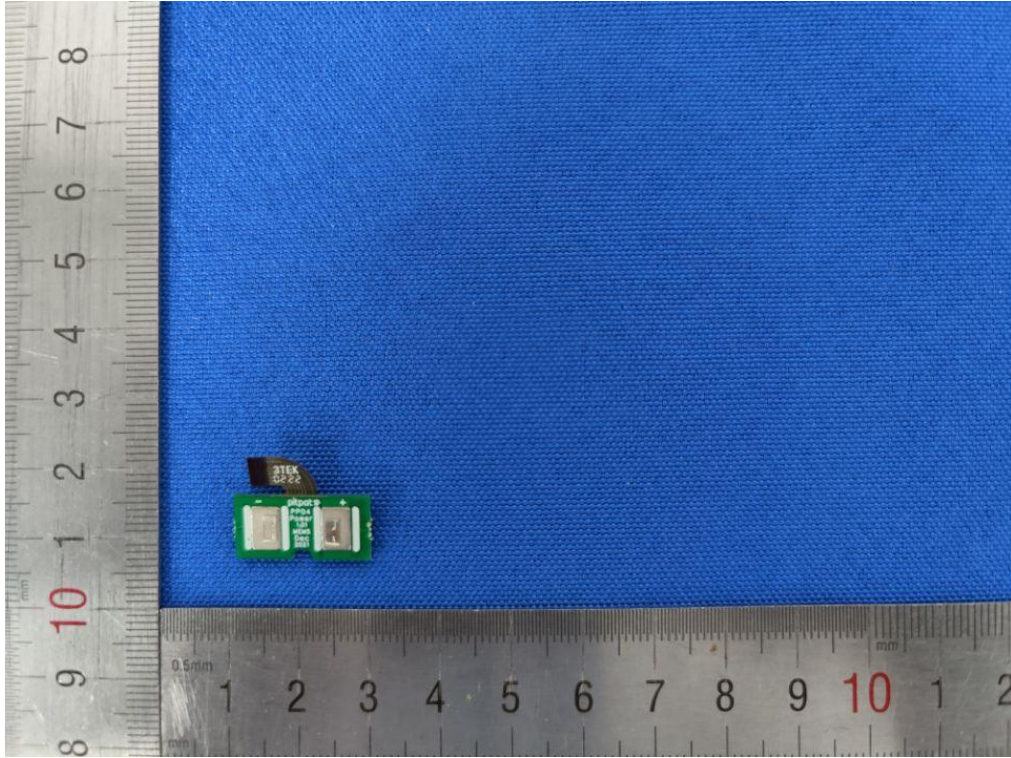

Figure 5 Trace view of PCB

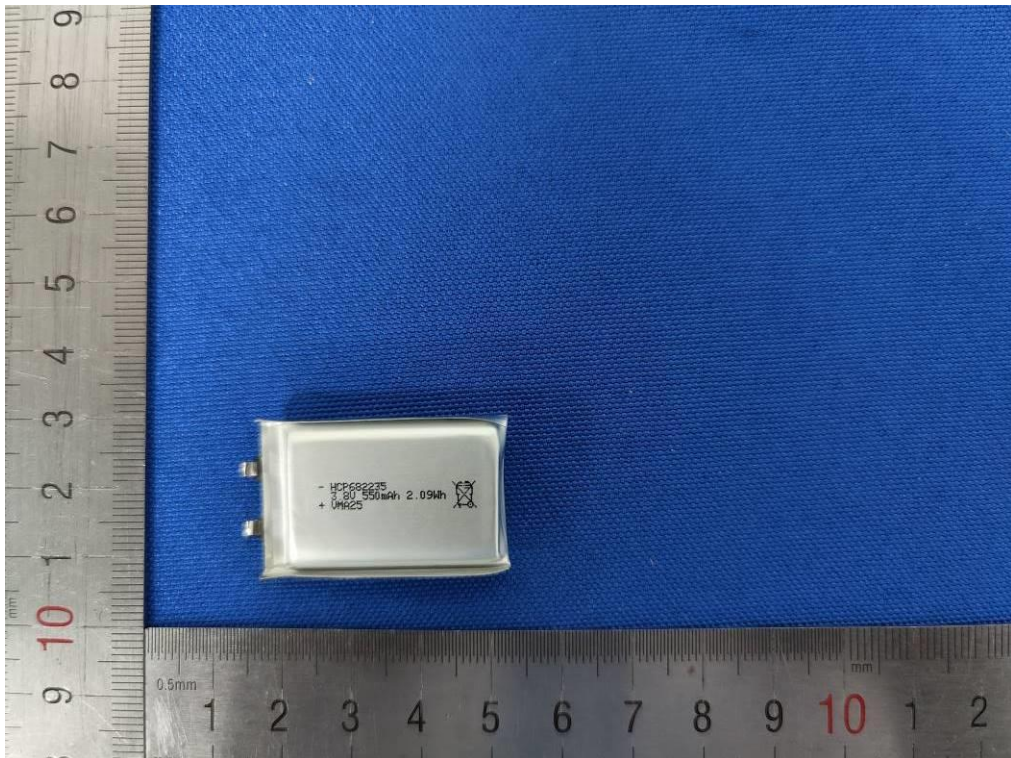

Figure 6 Front view of cell

Product: Lithium-ion polymer battery

Type Designation: HCP682235

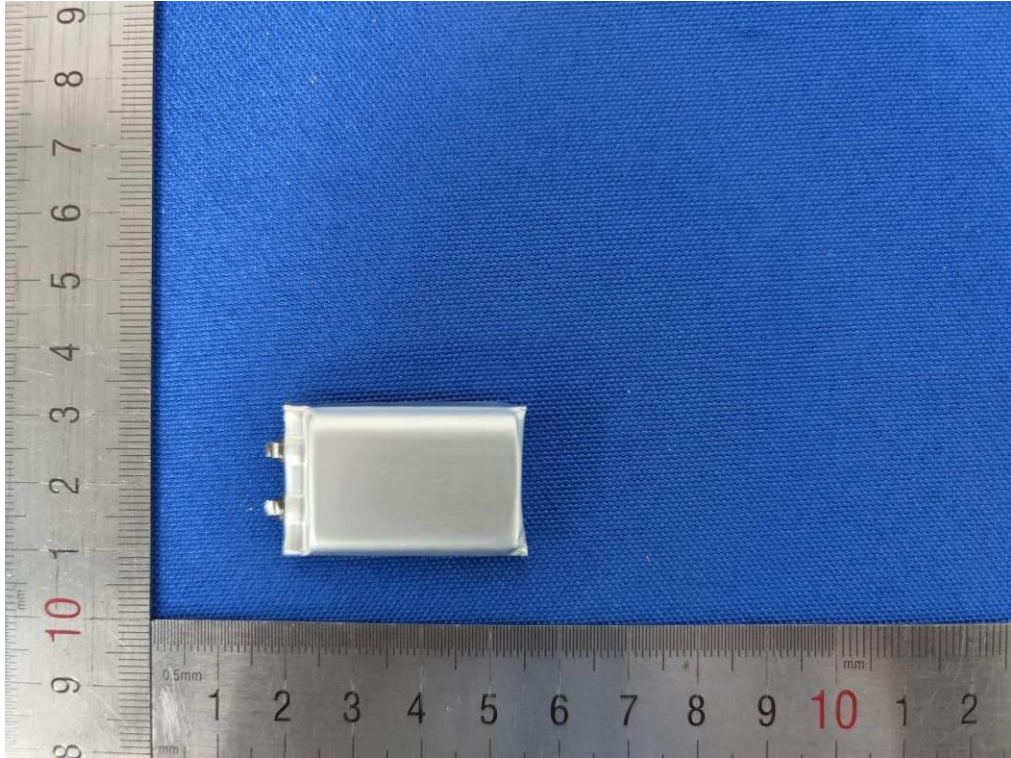

Figure 7 Back view of cell